



POLARIS® and HAMMERHEAD® are trademarks of POLARIS Industries Inc. Copyright 2016 POLARIS Industries Inc. All information contained within this publication is based on the latest product information at the time of publication. Due to constant improvements in the design and quality of production components, some minor discrepancies may result between the actual vehicle and the information presented in this publication. Depictions and/or procedures in this publication are intended for reference use only. No liability can be accepted for omissions or inaccuracies. Any reprinting or reuse of the depictions and/or procedures contained within, whether whole or in part, is expressly prohibited.

The original instructions for this vehicle are in English. Other languages are provided as translations of the original instructions.

Printed in U.S.A.
2017 R150 Owner's Manual
P/N 9927515

TABLE OF CONTENTS

Introduction	4
Safety	7
Features and Controls	20
Operation	26
Emission Control Systems	40
Maintenance	41
Specifications	79
Troubleshooting	83
Warranty	87
Maintenance Log	96
Index	98

INTRODUCTION

The R150 is an off-road vehicle. Familiarize yourself with all laws and regulations concerning the operation of this vehicle in your area.

The following signal words and symbols appear throughout this manual and on your vehicle. Your safety is involved when these words and symbols are used. Become familiar with their meanings before reading the manual.



The safety alert symbol indicates a potential personal injury hazard.

DANGER

A DANGER indicates a hazardous situation that, if not avoided, will result in death or serious injury.

WARNING

A WARNING indicates a hazardous situation that, if not avoided, could result in death or serious injury.

CAUTION

A CAUTION indicates a hazardous situation that, if not avoided, could result in minor or moderate injury.

NOTICE

A NOTICE indicates a situation that could result in property damage.



The Prohibition Safety Sign indicates an action NOT to take in order to avoid a hazard.



The Mandatory Action Sign indicates an action that NEEDS to be taken to avoid a hazard.

INTRODUCTION

WARNING

Failure to heed the warnings and safety precautions contained in this manual can result in severe injury or death. Your HAMMERHEAD vehicle is not a toy and can be hazardous to operate. This vehicle handles differently than cars, trucks or other off-road vehicles. A collision or rollover can occur quickly, even during routine maneuvers like turning, or driving on hills or over obstacles, if you fail to take proper precautions.

- Read this owner's manual. Understand all safety warnings, precautions and operating procedures before operating the vehicle. Keep this manual with the vehicle.
- This vehicle is an **ADULT VEHICLE ONLY**. You **MUST** be at least age 16 and have a valid driver's license to operate this vehicle.
- No person under the age of 12 may ride as a passenger in this vehicle. All riders must be able to sit with backs against the seat and both hands on the steering wheel (if driving) or on a passenger hand hold.
- Always keep hands, feet and all other body parts inside the vehicle at all times.
- Always wear a helmet, eye protection, gloves, long-sleeve shirt, long pants and over-the-ankle boots.
- Do not operate this vehicle at night or during periods of limited visibility.
- Never use this vehicle with drugs or alcohol, as these conditions impair judgment and reduce operator reaction time.
- Complete the New Operator Driving Procedures outlined on pages 32-33. Never allow a guest to operate this vehicle until the guest has watched the instructional video and has completed the New Operator Driving Procedures.

INTRODUCTION

Vehicle Identification Numbers

Record your vehicle's identification numbers and key number in the spaces provided. Remove the spare key and store it in a safe place.

Vehicle Identification Number
(On Frame Behind Driver Seat)

Engine Serial Number
(On Engine Case and Air Filter)



Manufacturing Data Label
(On Driver Side Floorboard)

Vehicle Model Number: _____

Vehicle Identification Number: _____

Engine Serial Number: _____

Key Number _____

Equipment Modifications

Your HAMMERHEAD vehicle is designed to provide safe operation when used as directed.

WARNING! Modifying this vehicle in any way can change the top speed, stability and handling performance of this vehicle. Modifications that increase speed, decrease stability or change performance may present a greater risk to inexperienced or younger operators and could result in loss of control and serious injury or death. Use only HAMMERHEAD-approved accessories to modify this vehicle. Review all vehicle changes prior to operating.

The HAMMERHEAD limited warranty on your HAMMERHEAD vehicle will be terminated if any non-HAMMERHEAD-approved equipment and/or modifications have been added to the vehicle that increase speed or power.

SAFETY

Safe Riding Gear

The driver and passenger must wear helmet, eye protection, gloves, long-sleeve shirt, long pants, over-the-ankle boots and seat belt at all times. Protective gear reduces the chance of injury.



Safe Riding Gear

Helmet

Wearing a helmet can prevent a severe head injury. Whenever riding this HAMMERHEAD vehicle, always wear a helmet that meets or exceeds established safety standards.

Approved helmets in the USA and Canada bear a U.S. Department of Transportation (DOT) label.

Approved helmets in Europe, Asia and Oceania bear the ECE 22.05 label. The ECE mark consists of a circle surrounding the letter E, followed by the distinguishing number of the country which has granted approval. The approval number and serial number will also be displayed on the label.

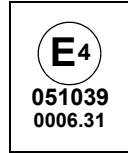

Eye Protection

Do not depend on eyeglasses or sunglasses for eye protection. Whenever riding this HAMMERHEAD vehicle, always wear shatterproof goggles or use a shatterproof helmet face shield. HAMMERHEAD recommends wearing approved Personal Protective Equipment (PPE) bearing markings such as VESC 8, V-8, Z87.1, or CE. Make sure protective eye wear is kept clean.

Gloves

Wear gloves for comfort and for protection from sun, cold weather and other elements.

Boots

Wear sturdy over-the-ankle boots for support and protection. Never ride a HAMMERHEAD vehicle with bare feet or sandals.

Clothing

Wear long sleeves and long pants to protect arms and legs.

Rider Comfort

Under certain operating conditions, heat generated by the engine and exhaust system can elevate temperatures in the driver and passenger cab area. The condition occurs most frequently when a vehicle is being operated in high ambient temperatures at low speeds and/or high load conditions for an extended period of time. The use of certain windshield, roof and/or cab systems may contribute to this condition by restricting airflow. Any discomfort due to heat buildup in this area can be minimized by wearing proper riding apparel and by varying speeds to increase airflow.

SAFETY

Safety Warnings

⚠ WARNING

Failure to operate this vehicle properly can result in a collision, loss of control, accident or rollover, which may result in serious injury or death. Heed all safety warnings outlined in this section of the owner's manual.

Be sure to read all of the following warnings about driving hazards and how to avoid them. The hazards outlined in this section of this owner's manual **MUST** be avoided at all times. See the OPERATION section of this owner's manual for proper operating procedures.

Operating Without Instruction

Operating this vehicle without proper instruction increases the risk of an accident. The operator must understand how to operate the vehicle properly in different situations and on different types of terrain. Complete the New Operator Driving Procedures outlined on pages 32-33.

All operators must read and understand this owner's manual and all warning and instruction labels before operating the vehicle. Never allow a guest to operate this vehicle until the guest has read this manual and all product labels and has completed the New Operator Driving Procedures outlined on pages 32-33.

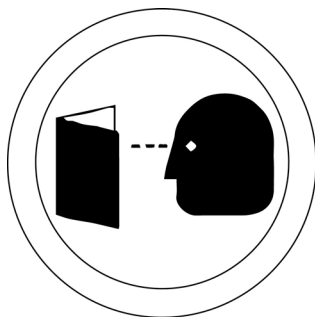

Operator Restrictions/Age Restrictions

This vehicle is an **ADULT VEHICLE ONLY**. Operation is prohibited for anyone under 16 years of age or anyone without a valid driver's license.

Never operate with a passenger under the age of 12. All riders must be able to sit with backs against the seat, both feet flat on the floor and both hands on the steering wheel (if driving) or on a passenger hand hold.



Safety Warnings

Rider Height

Some riders may be too tall to ride safely in this vehicle. Do not operate or ride in this vehicle if the clearance between the top of your helmet and the brush bars is less than 2 inches (5 cm).

Minimum
2 in (5 cm)



Seat Belts

Riding in this vehicle without wearing the seat belt increases the risk of serious injury in the event of rollover, loss of control, other accident or sudden stop. Seat belts may reduce the severity of injury in these circumstances. Riders *must* wear seat belts at all times. Always make sure the seat belts are secured for both the operator and passenger before riding.

Using Alcohol or Drugs

Riding in this vehicle after consuming alcohol or drugs could adversely affect operator judgment, reaction time, balance and perception.

Never consume alcohol or drugs before or while operating or riding in this vehicle.



Failure to Inspect Before Operating

Failure to inspect and verify that the vehicle is in safe operating condition before operating increases the risk of an accident.

Always inspect the vehicle before each use to make sure it's in safe operating condition. See page 28.

Always follow the inspection and maintenance procedures and schedules described in this owner's manual. See page 41.

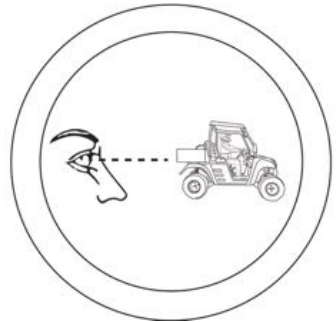

SAFETY

Safety Warnings

Protective Apparel

Riding in this vehicle without wearing an approved helmet and protective eyewear increases the risk of serious injury in the event of an accident.

Operator and passenger must always wear an approved helmet that fits properly and eye protection (goggles or face shield).



Carrying a Passenger

Never carry a passenger until you have operated this vehicle for at least four hours and have completed the New Operator Driving Procedures outlined on pages 32-33.

Carrying Multiple Passengers

A passenger must always be seated in a passenger seat with seat belt secured. Carrying more than one passenger in this vehicle can affect the operator's ability to steer and operate the controls, which increases the risk of loss of control and accident or rollover. Never carry more than one passenger in this vehicle.

Operating on Pavement

This vehicle's tires are designed for off-road use only, not for use on pavement. Operating this vehicle on paved surfaces (including sidewalks, paths, parking lots and driveways) may adversely affect the handling of the vehicle and may increase the risk of loss of control and accident or rollover. Avoid operating the vehicle on pavement.

Operating on Public Roads

Operating this vehicle on public streets, roads or highways could result in a collision with another vehicle. Never operate this vehicle on any public street, road or highway, including dirt and gravel roads (unless designated for off-highway use).



Safety Warnings

Operating at Excessive Speeds

Operating this vehicle at excessive speeds increases the operator's risk of losing control.

Always operate at a speed that's appropriate for the terrain, the visibility and operating conditions, your skills and experience and your passengers' skills and experience.

Turning Improperly

Turning improperly could cause loss of traction, loss of control, accident or rollover. Always follow proper procedures for turning as described in this owner's manual.

Never turn abruptly or at sharp angles. Never turn at high speeds. Practice turning at slow speeds before attempting to turn at faster speeds.



Jumps and Stunts

Exhibition driving increases the risk of an accident or rollover. DO NOT do power slides, "donuts", jumps or other driving stunts. Avoid exhibition driving.

Crossing Hillside

Driving on a sidehill is not recommended. Improper procedure could cause loss of control or rollover. Avoid crossing the side of any hill unless absolutely necessary.

If crossing a hillside is unavoidable, always follow proper procedures as described in this owner's manual. See page 37.



Physical Control of the Vehicle

Removing hands from the steering wheel or hand holds or removing feet from the floor while riding increases the risk of loss of control and accident or rollover.

The operator should always keep both hands on the steering wheel during operation. A passenger should always be seated in the passenger seat with both feet on the floor and with both hands securely grasping the hand holds.

Always keep hands and feet inside the vehicle at all times.

SAFETY

Safety Warnings

Driving Downhill Improperly

Driving down a hill improperly could cause loss of control or rollover. Always follow proper procedures for driving down a hill as described in this owner's manual. See page 37.



Improper Hill Climbing

Improper hill climbing could cause loss of control or rollover. Use extreme caution when operating on hills. Always follow proper procedures for hill climbing as described in this owner's manual. See page 36. Never operate the vehicle on hills steeper than 15 degrees.



Stalling While Climbing a Hill

Stalling or rolling backwards while climbing a hill could cause a rollover. Maintain a steady speed when climbing a hill.

If you lose all forward speed:

Apply the brakes gradually until the vehicle is fully stopped. Place the transmission in reverse and slowly allow the vehicle to roll straight downhill while applying light brake pressure to control speed.



Safety Warnings

Operating in Unfamiliar Terrain

Failure to use extra caution when operating on unfamiliar terrain could result in an accident or rollover.

Unfamiliar terrain may contain hidden rocks, bumps, or holes that could cause loss of control or rollover.

Travel slowly and use extra caution when operating on unfamiliar terrain. Always be alert to changing terrain conditions.



Operating on Sand or Slippery Terrain

Operating on sand or on excessively rough, slippery or loose terrain could cause loss of traction, loss of control, accident or rollover.

Always use extra caution when operating on sand or on rough, slippery or loose terrain. Do not operate on *excessively* rough, slippery or loose terrain.



Operating Improperly in Reverse

Improperly operating in reverse could result in a collision with an obstacle or person. Always follow proper operating procedures as outlined in this manual. See page 40.

Before shifting into reverse gear, always check for obstacles or people behind the vehicle. When it's safe to proceed, back slowly.



Overloading the Vehicle

Overloading the vehicle or carrying/towing loads may cause changes in stability and handling, which could cause loss of control or an accident.

- Never tow objects or carry loads over the maximum cargo limit.
- Never exceed the maximum weight capacity for this vehicle. See page 19.

SAFETY

Safety Warnings

Operating Over Obstacles

Improperly operating over obstacles could cause loss of control or rollover.

Before operating in a new area, check for obstacles. Never attempt to operate over large obstacles such as large rocks or fallen trees. Always follow the proper procedures outlined in this manual when operating over obstacles. See page 39.



Operating Through Water

Operating through deep or fast-flowing water can cause loss of traction, loss of control, rollover or accident. Never operate in fast-flowing water or in water that exceeds the floor level.

Always follow proper procedures for operating in water as described in this owner's manual. See page 38.

Wet brakes may have reduced stopping ability. After leaving water, test the brakes. Apply them lightly several times while driving slowly. The friction will help dry out the pads.



Operating on Frozen Bodies of Water

Operating on frozen bodies of water can result in the vehicle and/or riders falling through the ice. Never operate this vehicle on a frozen body of water.

Improper Tires and Maintenance

Operating this vehicle with improper tires or with improper or uneven tire pressure could cause loss of control, accident or rollover. Always use the size and type of tires specified for your vehicle. Always maintain proper tire pressure as described in this owner's manual and on safety labels.



Safety Warnings

Operating a Damaged Vehicle

Operating a damaged vehicle can result in an accident. After any rollover or other accident, have a qualified service dealer inspect the entire machine for possible damage, including (but not limited to) seat belts, rollover protection devices, brakes, throttle and steering systems.

Refueling

Gasoline is highly flammable and is explosive under certain conditions. Always exercise extreme caution whenever handling gasoline.

- Never allow a child to refuel or handle gasoline.
- Always stop the engine when refueling.
- Always refuel outdoors or in a well ventilated area.
- Do not smoke or allow open flames or sparks in or near the refueling area or where gasoline is stored.
- Never refuel while a person is in the vehicle.
- Do not over fill the tank. Do not fill the tank neck.
- If gasoline spills on your skin or clothing, immediately wash it off with soap and water and change clothing.

Exposure to Exhaust

Engine exhaust fumes are poisonous and can cause loss of consciousness or death in a short time. Never start the engine or let it run in an enclosed area.

Operate this vehicle only outdoors or in well-ventilated areas.

Hot Exhaust Systems

Exhaust system components are very hot during and after use of the vehicle. Hot components can cause burns and fire. Do not touch hot exhaust system components. Always keep combustible materials away from the exhaust system.

Use caution when traveling through tall grass, especially dry grass. Always inspect the underside of the vehicle and areas near the exhaust system after driving through tall grass, weeds, brush and other tall ground cover. Promptly remove any grass or debris clinging to the vehicle.

Unauthorized Use of the Vehicle

Leaving the keys in the ignition can lead to unauthorized use of the vehicle by someone under the age of 16, without a drivers license, or without proper training. This could result in an accident or rollover. Always remove the ignition key when the vehicle is not in use.

SAFETY

Safety Labels and Locations

Warning labels have been placed on the vehicle for your protection. Read and follow the instructions on each label carefully. If any of the labels shown in this manual differ from the labels on your vehicle, always read and follow the instructions of the labels on the *vehicle*.

If an informational or graphic label becomes illegible or comes off, contact your HAMMERHEAD dealer to purchase a replacement. Replacement *safety* labels are provided by HAMMERHEAD at no charge.

WARNING! This utility vehicle can be hazardous to operate if driven carelessly. Injuries can result if you do not follow these instructions:

- Read owner's manual and all labels before you operate this utility vehicle.
- Never operate this utility vehicle without proper instructions. Beginners require adult supervision.
- Never operate this utility vehicle on public roads. It is intended for off-road use only.
- Always wear an approved motorcycle helmet, eye protection and protective clothing.
- Never operate this utility vehicle at excessive speeds. You increase your risk of losing control if you operate it at speeds too fast for the terrain, visibility conditions or your experience.
- Never attempt wheelies, jumps, or other stunts.

WARNING! No Long Hair

All hair must be tied up and secured at or above shoulder length. All loose clothing must be secured. all necklaces and scarves must be secured.



Safety Labels and Locations

WARNING! Loss of control, collision, or getting caught in moving parts can result in serious injuries.

- No operation under age of 16 allowed.
- Wear a D.O.T. approved motorcycle helmet.
- Secure long hair and loose clothing.
- Wear protective eye wear and clothing.
- Keep arms, legs and feet inside the vehicle.
- Do not use alcohol or drugs.

WARNING!

- Moving parts can crush and cut.
- Keep hands clear.
- Do not operate with guards removed.

WARNING! Seat belt must be worn at all times.

CAUTION! This vehicle manufactured for off-road use only. Do not operate on public streets, roads, or highways.



WARNING! No Riding



FEATURES AND CONTROLS

Component Locations



FEATURES AND CONTROLS

Seat Belts

This HAMMERHEAD vehicle is equipped with seat belts for all riders. **ALWAYS** make sure the seat belts are secured for the operator and passenger before riding.

3-Point Seat Belts

To wear the 3-point seat belts properly, do the following:

1. Hold the latch plate as you pull the belt across your lap and chest. Make sure the belt is not twisted and is not caught on any portion of the vehicle, your clothing, or any equipment you are carrying.
2. Push the latch plate into the buckle until it clicks. Pull up on the latch plate to make sure it is secure.
3. Put the lap portion of the belt low on your hips. Push down on the buckle end of the belt as you pull up on the shoulder part so the belt is snug across your hips.
4. Position the shoulder belt over your shoulder and across your chest. The shoulder belt should fit against your chest. If it is loose, pull the belt out all the way and then let it retract.
5. To release the buckle, firmly press the release button.

Seat Belt Inspection

Inspect all seat belts for proper operation before each use of the vehicle.

1. Push latch plates into the buckle until they click. The latch plates must slide smoothly into the buckle. A click indicates that it's securely latched.
2. Push the red release latch in the middle of the buckle to make sure it releases freely.
3. Pull each seat belt completely out and inspect the full length for any damage, including cuts, wear, fraying or stiffness. If any damage is found, or if the seat belt does not operate properly, have the seat belt system checked and/or replaced. Your dealer can assist.
4. To clean dirt or debris from the seat belts, sponge the straps with mild soap and water. Do not use bleach, dye or household detergents. Use a garden hose to flush out the retractor and latch housings regularly.

FEATURES AND CONTROLS

Switches

Ignition Switch

The ignition switch is a three-position, key-operated switch. The key can be removed from the switch when it is in the OFF position.

OFF	All electrical circuits are switched off. The key can be removed in this position.
ON	All electrical circuits are supplied with power, and the headlights and taillights are operable.
IGNITION	The electrical starter is engaged by turning and holding the key in this position. Release the key when the engine starts.

CAUTION!

- Do not operate the electric starter continuously for more than 5 seconds, or damage may occur.
- Wait at least 5 seconds between each operation of the electric starter, allowing it to cool.
- Do not commence the electric starter while the engine is running, or damage may occur.

Light Switch

The ignition switch key must be in the ON position to operate the headlights. Press the top of the rocker switch for high beams. Press the bottom of the rocker switch for low beams.

High
Beam



Low
Beam

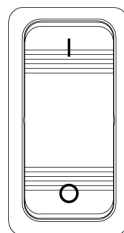

FEATURES AND CONTROLS

Auxiliary Outlet

The vehicle is equipped with a 12-volt accessory outlet on the dash. Use the outlet to power an auxiliary light or other optional accessories or lights. For service, the dash outlet connection is under the dash.

Horn

The vehicle is equipped with horn. To use, press in on horn tab.

FEATURES AND CONTROLS

Drive Select Lever

D: Drive

N: Neutral

R: Reverse

The drive select lever is used to shift your vehicle into Drive, Neutral, and Reverse (D, N, R).

Tip: Sometimes it may be difficult to select into the drive due to a locked-up transmission. Move the vehicle with your weight to unlock the gears if this happens.

NOTICE: Do not attempt to shift the transmission while the vehicle is moving or damage to the transmission could result. Always shift when the vehicle is stationary and the engine is at idle.

Drive Select Lever



Parking Brake

The parking brake lever is located in between the driver seat and the passenger seat. To operate the parking brake, do the following.

- **To set the parking brake,** press the release button and pull up on the lever.
- 5. **To release the parking brake,** press the release button and release the lever.

Tip: Always set the parking brake whenever the vehicle is left unattended.

Parking Brake



WARNING! Operating the vehicle while the parking brake is engaged could cause an accident resulting in serious injury or death. It could also result in driveline or engine damage. Always be sure to disengage the parking brake before operating the vehicle.

FEATURES AND CONTROLS

Brake Pedal

Depress the brake pedal to slow or stop the vehicle. Apply the brakes while starting the engine.

Throttle Pedal

Push the pedal down to increase engine speed. Spring pressure returns the pedal to the rest position when released. Always check that the throttle pedal returns normally before starting the engine. Make sure there's adequate throttle pedal freeplay. See page 60 for throttle pedal adjustment procedures.



Brake
Pedal

Throttle
Pedal

Mechanical Speed Control System

The adjustable throttle limiting screw is located behind the throttle pedal. Use the following procedure to control how far the throttle opens.

1. Remove limiter bolt.
2. Add washers underneath limiter bolt head until desired max speed is reached.

Fuel Cap

The fuel tank is located underneath the vehicle's seat bottom. Pull the vehicle's seat bottom up to reveal access to fuel tank cap.

WARNING! Only use unleaded grade gasoline.



OPERATION

⚠ WARNING

Failure to operate the vehicle properly can result in a collision, loss of control, accident or rollover, which may result in serious injury or death. Read and understand all safety warnings outlined in the safety section of this owner's manual.

Vehicle Break-in Period

The break-in period for your new HAMMERHEAD vehicle is defined as the first five (5) hours of operation.

No single action on your part is as important as a proper break-in period. Careful treatment of a new engine and drive components will result in more efficient performance and longer life for these components. Perform the following procedures carefully.

NOTICE: Excessive heat build-up during the first three hours of operation will damage close-fitted engine parts and drive components. Do not operate at full throttle or high speeds during the first three hours of use.

Mixing brands or using a non-recommended oil may cause serious engine damage. Always use the recommended oil. Never substitute or mix oil brands.

Vehicle Break-in Period

Engine and Drivetrain Break-in

1. Fill the fuel tank with gasoline. Always exercise extreme caution whenever handling gasoline. See “Refueling” on page 17.
2. Check the oil level. See page 47. Add the recommended oil as needed to maintain the oil level in the safe operating range.
3. Complete the New Operator Driving Procedures outlined on pages 32-33.
4. Avoid aggressive use of the brakes. See Brake System Break-in below.
5. Vary throttle positions. Do not operate at sustained idle.
6. Perform regular checks on fluid levels, controls and areas outlined on the daily pre-ride inspection checklist. See page 28.
7. Change the engine oil at five (5) hours.
8. Adjust and lubricate the drive chain at five (5) hours.

Brake System Break-in

Apply only moderate braking force for the first 50 stops. Aggressive or overly forceful braking when the brake system is new could damage brake pads and rotors.

CVT Break-in (Clutches/Belt)

A proper break-in of the clutches and drive belt will ensure a longer life and better performance. Break in the clutches and belt by operating at slower speeds during the break-in period as recommended. Avoid aggressive acceleration and high speed operation during the break-in period.

OPERATION

Pre-Ride Inspection

Failure to inspect and verify that the vehicle is in safe operating condition before operating increases the risk of an accident. Always inspect the vehicle before each use to make sure it's in safe operating condition.

Item	Remarks	Page
Brake system/pedal travel	Ensure proper operation	25 61
Brake fluid	Ensure proper level	62
Front suspension	Inspect, lubricate if necessary	46
Rear suspension	Inspect, lubricate if necessary	46
Steering	Ensure free operation	63
Tires	Inspect condition and pressure	19 65
Wheels/fasteners	Inspect, ensure fastener tightness	66
Frame nuts, bolts, fasteners	Inspect, ensure tightness	-
Fuel and oil	Ensure proper levels	25 47
Grass and debris	Remove grass and debris from the vehicle, especially on the underside and near the exhaust system	-
Throttle	Ensure proper operation	59
Indicator lights/switches	Ensure proper operation	-
Air filter	Inspect and clean or replace	58
Daytime running lights	Ensure proper operation	67
Brake light	Ensure proper operation	-
Seat Latches	Move the seats forward and rearward to ensure correct installation	21
Seat Belts	Check length of belt for damage, check latches for proper operation	21

Safe Operation Practices

1. Visit the Recreational Off-Highway Vehicle Association web site (rohva.org) and take the free on-line training course. Complete the recommended safety training before operating this vehicle.
2. Do not allow anyone under 16 years of age or without a valid driver's license to operate this vehicle.
3. Never operate with a passenger under the age of 12. Never carry more one passenger in a 2-seat vehicle. Never allow a passenger to ride in the cargo box.
4. Engine exhaust fumes are poisonous. Never start the engine or let it run in an enclosed area.
5. Never operate with accessories not approved by HAMMERHEAD for use on this vehicle.
6. Operate this vehicle off-road only. Never operate the vehicle on pavement or on any public street, road or highway, including dirt and gravel roads.
7. Drive in a manner appropriate for your skills and operating conditions. Never operate at excessive speeds. Never attempt wheelies, jumps, or other stunts. Keep both hands on the steering wheel during operation.
8. Never consume alcohol or drugs before or while operating this vehicle.
9. Always use the size and type of tires specified for your vehicle. Always maintain proper tire pressure.
10. Never operate a damaged vehicle. After any rollover or accident, have a qualified service dealer inspect the entire machine for possible damage.
11. Never operate the vehicle on a frozen body of water unless you have first verified that the ice is sufficiently thick to support the weight and moving force of the vehicle, you and your passenger, and your cargo, together with any other vehicles in your party.
12. Do not touch hot exhaust system components. Always keep combustible materials away from the exhaust system.
13. Always remove the ignition key when the vehicle is not in use to prevent unauthorized use.

OPERATION

Starting the Engine

1. Sit in the driver's seat and fasten the seat belt.
2. Place the transmission in neutral. Set the parking brake.
3. Apply the brakes.
4. If the engine is cold, use full choke by pulling the choke all the way out. A warm engine will not require the use of the choke.

Tip: The choke is fully on when it's pulled out. The choke is off when it's completely pushed in. The choke can be adjusted gradually depending on how much choke is needed for starting.

5. Do not press the throttle pedal while starting the engine.
6. Turn the ignition key past the ON/RUN position to START. Engage the starter for a maximum of five seconds. Release the key when the engine starts.

NOTICE: Operating the vehicle immediately after starting could cause engine damage. Allow the engine to warm up for several minutes before operating the vehicle.

7. If the engine does not start within five seconds, return the ignition switch to the OFF position and wait five seconds. Repeat steps 6 and 7 until the engine starts.
8. Vary the engine RPM slightly with the throttle to aid in warm-up until the engine idles smoothly.
9. Release the parking brake before driving.

Stopping the Engine

1. Release the throttle pedal completely and brake to a complete stop.
2. Place the transmission in neutral.
3. Set the parking brake.
4. Stop the engine.
5. Turn key to off position

Braking

1. Release the throttle pedal completely. (When the throttle pedal is released completely and engine speed slows to near idle, the vehicle has no engine braking.)
2. Press on the brake pedal evenly and firmly. Practice starting and stopping (using the brakes) until you're familiar with the controls.

Parking the Vehicle

1. Stop the vehicle on a level surface. When parking inside a garage or other structure, be sure that the structure is well ventilated and that the vehicle is not close to any source of flame or sparks, including any appliance with pilot lights.
2. Place the transmission in neutral.
3. Set the parking brake.
4. Stop the engine.
5. Remove the ignition key to prevent unauthorized use.

OPERATION

New Operator Driving Procedures



1. Read and understand this owner's manual and all warning and instruction labels before operating this vehicle.
2. Visit the Recreational Off-Highway Vehicle Association web site (rohva.org) and take the free on-line training course. Hands-on training is also available through ROHVA.
3. Review the section of this owner's manual about starting the engine, stopping the engine, braking and parking (pages 30-31).
4. Perform the pre-ride inspection (page 28).
5. The driver and passenger must wear helmet, eye protection, gloves, long-sleeve shirt, long pants, over-the-ankle boots and seat belt at all times.
6. Do not operate or ride in this vehicle if the clearance between the top of your helmet and brush bar is less than 2 inches (5 cm).

(continued on next page)



New Operator Driving Procedures

7. Select a level open area to practice driving. Make sure you have permission to drive in this area.
8. Sit in the driver's seat and fasten the seat belt.
9. Make sure all passengers secure their seat belts.
10. Do not carry a passenger until you have at least four hours of driving experience with this vehicle. See page 34.
11. Set the parking brake.
12. Place the transmission in neutral.
13. Start the engine. See “Starting the Engine” on page 30.
14. Apply the brakes and shift into gear.
15. Release the parking brake.
16. Check your surroundings. Make sure the area is clear of people and obstacles.
17. Keeping both hands on the steering wheel, slowly release the brakes and press the throttle with your right foot to begin driving.
18. Drive slowly at first. Practice starting, stopping, turning, using the throttle and brakes and driving in reverse. Learn how the vehicle handles when making both left and right turns at a slow speed.
19. Increase speed only after mastering all maneuvers at a slow speed.
20. After you become skilled at making turns and begin to operate at faster speeds, follow these precautions:
 - Avoid sharp turns. Make turns gradually.
 - Never turn while applying heavy throttle.
 - Never turn the steering wheel abruptly.
 - Operate at speeds appropriate for your skills, the conditions and the terrain.
 - DO NOT attempt to do power slides, “donuts”, jumps or other driving stunts.

OPERATION

Driving with a Passenger

1. Complete the New Operator Driving Procedures outlined on pages 32-33.
2. Perform the pre-ride inspection. See page 28.
3. Do not carry a passenger until you have at least four hours of driving experience with this vehicle.
4. Make sure the passenger is at least 12 years of age. All riders must be able to sit with backs against the seat, both feet flat on the floor and both hands on the steering wheel (if driving) or on a passenger hand hold.
5. Make sure the passenger has at least 2 inches (5 cm) of clearance between his helmet and the brush bars.
6. Never carry more than one passenger in this vehicle.
7. Never allow a passenger to ride on the back of the vehicle. Allow a passenger to ride only in the passenger seat.
8. Make sure the passenger is wearing helmet, eye protection, gloves, long-sleeve shirt, long pants and over-the-ankle boots. See page 8.
9. Make sure the passenger secures the seat belt.
10. Tell your passenger to always keep hands and feet inside the vehicle at all times.
11. Drive slowly. Vehicle handling may change with a passenger on board. Always travel at a speed appropriate for your skills, your passenger's skills, and operating conditions. Avoid unexpected or aggressive maneuvers that could cause discomfort or injury to a passenger.
12. Always follow all operating guidelines as outlined on safety labels and in this manual.

Driving on Slippery Surfaces

When driving on slippery surfaces such as wet trails, loose gravel, sand or ice, be alert for the possibility of skidding and sliding.

Follow these precautions when driving in slippery conditions:

1. Slow down before entering slippery areas.
2. Be alert, watch the path ahead and avoid quick turns, which can cause skids.
3. Correct a skid by turning the steering wheel in the direction of the skid. *Never apply the brakes during a skid.*

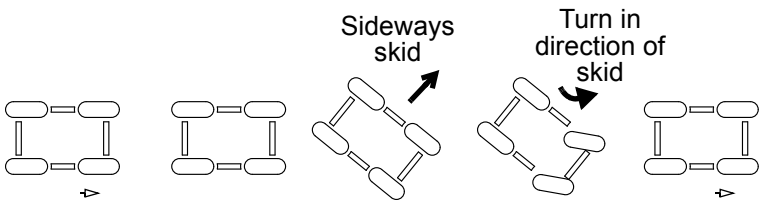

OPERATION

Driving Uphill

Whenever traveling uphill, follow these precautions:

1. Always check the terrain carefully before ascending a hill. Never drive on hills with excessively slippery or loose surfaces.
2. Avoid excessively steep hills (15° maximum).
3. Drive straight uphill.
4. Drive at a steady rate of speed. Never press the throttle suddenly.
5. Avoid unnecessary changes in speed or direction.
6. Never go over the crest of a hill at a high speed. An obstacle, a sharp drop, or another vehicle or person could be on the other side of the hill.
7. If the vehicle stalls while climbing a hill, apply the brakes. Place the transmission in reverse and slowly allow the vehicle to roll straight downhill while applying the brakes lightly to control speed.

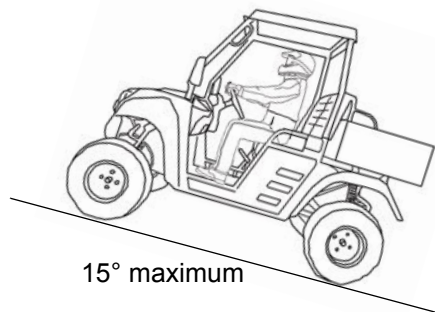

Driving on a Sidehill (Sidehilling)

Driving on a sidehill is not recommended. Driving on a sidehill improperly cause loss of control or rollover.

If crossing a hill is *unavoidable*, follow these precautions:

1. Drive slowly and use extreme caution.
2. If the vehicle begins to roll over, or if it feels as if it may roll over, *immediately* turn downhill.
3. Avoid obstacles and changes in terrain that may lower or raise one side of the vehicle or cause the vehicle to slide.
4. If the vehicle begins to slide downhill, immediately turn downhill to stop the slide, or stop the vehicle and maneuver slowly and carefully until the vehicle can be driven straight downhill.

Driving Downhill

Whenever driving down a hill, follow these precautions:

1. Avoid excessively steep hills (15° maximum).
2. Slow down. Never travel down a hill at high speed.
3. Always check the terrain carefully before driving down a hill. Never drive on hills with excessively slippery or loose surfaces.
4. Always drive down a hill with the transmission in forward gear. *Never “coast” or drive down a hill with the transmission in neutral.*
5. Avoid driving down a hill at an angle, which would cause the vehicle to lean sharply to one side. Always drive straight downhill.
6. Apply the brakes *lightly* to keep speed slow.

OPERATION

Driving Through Water

Your vehicle can drive through shallow water. Make sure the water is no deeper than the floor of the vehicle. Follow these precautions when driving through water:

1. Check water depth. Never drive through water that is deeper than the floor level.
2. After driving through water, test the brakes. Apply them lightly several times while driving slowly. The friction will help dry out the pads.

NOTICE: Major engine damage can result if the vehicle is not thoroughly inspected after operation in water. Perform the services outlined in the maintenance chart. See page 41. Give special attention to engine oil, transmission oil and all grease fittings.

If your vehicle becomes immersed or is operated in water that exceeds the floor level, *service is required before starting the engine*. Your HAMMERHEAD dealer can provide this service. If it's impossible to bring the vehicle in before starting the engine, perform the service outlined on page 68, and take the vehicle in for service at the first opportunity.

Driving in Reverse

Follow these precautions when driving in reverse:

1. Always check for obstacles or people behind the vehicle.
2. Apply the throttle *lightly*. Never apply the throttle suddenly.
3. Back slowly.
4. Apply the brakes lightly for stopping.
5. Avoid making sharp turns.

Parking on an Incline

A rolling vehicle can result in serious injury. Avoid parking on an incline. If parking on an incline is *unavoidable*, follow these precautions:

1. Place the transmission in neutral.
2. Set the parking brake.
3. Stop the engine.
4. Always block the rear wheels on the downhill side.

Driving Over Obstacles

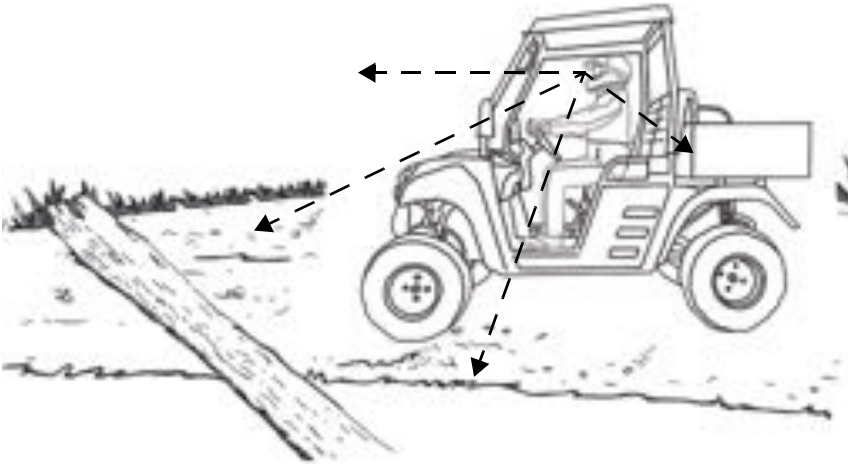

Follow these precautions when driving over obstacles:

1. Always check for obstacles before driving in a new area.
2. Look ahead and watch the terrain. Always be alert for hazards such as logs, rocks and low hanging branches.
3. Drive slowly and use extra caution when driving on unfamiliar terrain. Obstacles are not always clearly visible.
4. Do not drive over large obstacles such as large rocks and fallen trees. If it's unavoidable, use extreme caution and drive slowly.
5. Always have a passenger dismount and move away from the vehicle before driving over an obstacle that could cause a rollover.

EMISSION CONTROL SYSTEMS

Noise Emission Control System

Do not modify the engine, intake or exhaust components, as doing so may affect compliance with U.S.A. EPA noise control requirements and local noise level requirements.

Crankcase Emission Control System

This engine is equipped with a closed crankcase system. Blow-by gases are forced back to the combustion chamber by the intake system. All exhaust gases exit through the exhaust system.

Periodic Maintenance Chart

Any qualified repair shop or person may maintain, replace or repair the emission control devices or systems on your vehicle. An authorized HAMMERHEAD dealer can perform any service that may be necessary for your vehicle. HAMMERHEAD also recommends HAMMERHEAD parts for emissions-related service, however equivalent parts can be used.

It is a potential violation of the Clean Air Act if a part supplied by an aftermarket parts manufacturer reduces the effectiveness of the vehicle's emission controls. Tampering with emission controls is prohibited by federal law.

Owners are responsible for performing the scheduled maintenance identified in this owner's manual.

Careful periodic maintenance will help keep your vehicle in the safest, most reliable condition. Inspection, adjustment and lubrication of important components are explained in the periodic maintenance chart.

Inspect, clean, lubricate, adjust and replace parts as necessary. When inspection reveals the need for replacement parts, genuine HAMMERHEAD parts are available from your HAMMERHEAD dealer. Equivalent parts may be used for emissions-related service.

Record maintenance and service in the Maintenance Log beginning on page 96.

Service and adjustments are important for proper vehicle operation. If you're not familiar with safe service and adjustment procedures, a qualified dealer can perform these operations.

Vehicles subjected to heavy or severe use patterns must be inspected and serviced more frequently.

Severe Use Definition

- Frequent immersion in mud, water or sand
- Racing or race-style high RPM use
- Prolonged low speed operation
- Extended idle
- Short trip cold weather operation

Pay special attention to the oil level. A rise in oil level during cold weather can indicate contaminants collecting in the oil sump or crankcase. Change oil immediately if the oil level begins to rise. Monitor the oil level, and if it continues to rise, discontinue use and determine the cause. Your HAMMERHEAD dealer can assist.

MAINTENANCE

Periodic Maintenance Chart

Maintenance Chart Key

Symbol	Description
▶	Perform these operations more often for vehicles subjected to severe use.
D	Have an authorized HAMMERHEAD dealer or other qualified person perform these services.

WARNING! Improperly performing the procedures marked with a “D” could result in component failure and lead to serious injury or death. Have an authorized HAMMERHEAD dealer or other qualified person perform these services.

MAINTENANCE

Periodic Maintenance Chart

Perform all services at whichever maintenance interval is reached first.

Item	Maintenance Interval (whichever comes first)			Remarks
	Hours	Calendar	Miles (Km)	
Steering	-	Daily	-	Check each day before driving the vehicle. Make adjustments as needed. See the Pre-Ride Checklist on page 28.
Front suspension	-		-	
Rear suspension	-		-	
Tires	-		-	
Brake fluid level	-		-	
Brake pedal travel	-		-	
Brake system	-		-	
Wheels/fasteners	-		-	
Frame fasteners	-		-	
Engine oil level	-		-	
Fuel Tank		Daily		Add Carbon Clean with each fuel fill
▶ Air filter	-	Daily	-	Inspect; clean often; replace as needed
Airbox Sediment Tube		Daily		Drain when deposits are visible
Daytime running lights/taillight	-	Daily	-	Check operation
Drive chain	-	Daily	-	Inspect; adjust, lubricate, replace as needed
CVT housing (if equipped)	-	Weekly	-	Drain water as needed, check often if driving in wet conditions
▶ D Brake pad wear	10	Monthly	100 (160)	Inspect periodically
D Choke (if equipped)	10	Monthly	100 (160)	Check for proper operation; your dealer can assist
Idle Speed	10	Monthly	100 (160)	Check, adjust as needed
Valve Clearance (Initial)	10	Monthly	100 (160)	Valve lash adjustment: Every 40 hours after first 10 hour adjustment
▶ Engine oil change (break-in)	5	Monthly	-	Perform a Break-in Oil Change at one month
Drive chain (break-in)	5	Monthly	-	Adjust and lubricate

▶ Perform these procedures more often for vehicles subjected to severe use.

D Have an authorized HAMMERHEAD dealer or other qualified person perform these services.

MAINTENANCE

Periodic Maintenance Chart

Item	Maintenance Interval (whichever comes first)			Remarks
	Hours	Calendar	Miles (Km)	
Fuel System	25	Monthly	-	Inspect; check lines and fittings for leaks and abrasion
Battery	25	Monthly	250 (400)	Check terminals; clean; test
▶ Main gearcase oil	25	Monthly	250 (400)	Inspect level; change yearly
▶ Engine breather filter (if equipped)	25	1 M	150 (250)	Inspect; replace if necessary
▶ Engine oil change	30	6 M	300 (480)	Change Oil; Use 10w40 (SN) Conventional Engine Oil
▶ General lubrication	50	3 M	500 (800)	Lubricate all fittings, pivots, cables, etc.
Shift Linkage	50	6 M	500 (800)	Inspect, lubricate, adjust
D Steering	50	6 M	500 (800)	Lubricate
▶ Front Suspension	50	6 M	500 (800)	Lubricate
▶ Rear Suspension	50	6 M	500 (800)	Lubricate
D Choke Cable	50	6 M	500 (800)	Inspect; adjust; lubricate; replace if necessary. Your dealer can assist.
Carburetor Float Bowl	50	6 M	500 (800)	Drain bowl periodically, and prior to storage.
Carb Intake Ducts	50	6 M	500 (800)	Inspect duct for proper sealing/air leaks
D Valve Clearance	50	-	500 (800)	Adjust valve lash every 40 hours after first 10 hours
D Fuel system/filter	100	12 M	600 (1000)	Inspect; Clean/Replace if necessary. Check for leaks at tank cap, filter, and carburetor.
▶ Spark plug	100	12M	600 (1000)	Check, Replace as necessary, torque to specification

- ▶ Perform these procedures more often for vehicles subjected to severe use.
D Have an authorized HAMMERHEAD dealer or other qualified person perform these services.

MAINTENANCE

Periodic Maintenance Chart

Item	Maintenance Interval (whichever comes first)			Remarks
	Hours	Calendar	Miles (Km)	
▶ Engine mounts	100	12 M	1000 (1600)	Inspect
Exhaust muffler/ pipe	100	12 M	1000 (1600)	Inspect
D Ignition timing	100	12 M	1000 (1600)	Inspect
▶ Wiring	100	12 M	1000 (1600)	Inspect for wear, routing, security; apply dielectric grease to connectors subjected to water, mud, etc.
D Clutches (drive and driven)	100	12 M	1000 (1600)	Inspect; clean; replace worn parts
Drive belt	100	12 M	1000 (1600)	Inspect; replace as needed
D Front wheel bearings	100	12 M	1000 (1600)	Inspect; replace as needed
D Brake fluid	200	24 M	2000 (3200)	Change every two years
Spark arrester	300	36 M	3000 (4800)	Clean out
D Toe adjustment	-			Inspect periodically; adjust when parts are replaced

▶ Perform these procedures more often for vehicles subjected to severe use.

D Have an authorized HAMMERHEAD dealer or other qualified person perform these services.

MAINTENANCE

Lubrication Recommendations

Check and lubricate all components at the intervals outlined in the Periodic Maintenance Chart beginning on page 41, or more often under severe use, such as wet or dusty conditions. Items not listed in the chart should be lubricated at the general lubrication interval.

Item	Lube	Method
Engine Oil	10w40 Conventional Engine Oil	See page 47.
Brake Fluid	DOT 4 Brake Fluid	See page 62.
Transmission Oil (Main Gearcase)	AGL Gearcase Lubricant & Transmission Fluid	See page 51.
Drive Chain	Chain Lube or SAE 80/90	See page 52.
A-Arm Pivots	All Season Grease or grease conforming to NLGI No. 2	Grease at general lubrication interval, also after washing vehicle or driving in water.
▶ Steering Arm Pivots		

▶ Perform these procedures more often for vehicles subjected to severe use.

Engine Oil

Oil Recommendations

Always check and change the engine oil at the intervals outlined in the Periodic Maintenance Chart beginning on page 41. HAMMERHEAD recommends the use of 10w40 Conventional Engine Oil for this vehicle.

NOTICE: Mixing brands or using a non-recommended oil may cause serious engine damage. Always use the recommended oil. Never substitute or mix oil brands.

Oil Check

Maintain the oil level within the safe range on the dipstick. Do not overfill.

1. Position the vehicle on a level surface.
2. Remove the dipstick. Wipe it dry with a clean cloth.
3. Reinstall the dipstick completely.
4. Remove the dipstick and check the oil level.

Tip: A rising oil level between checks in cool weather driving can indicate contaminants such as gas or moisture collecting in the crankcase. If the oil level is over the full/safe mark, change the oil immediately.

5. Add the recommended oil as needed.
6. Reinstall the dipstick.

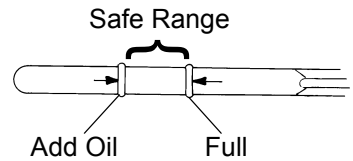
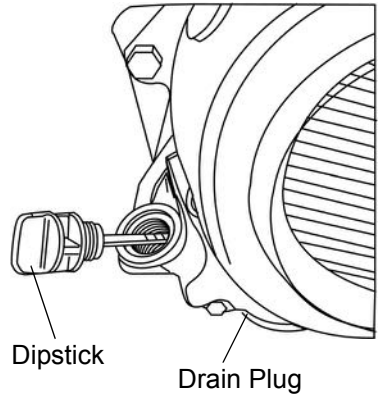

Fuel Filter

This vehicle is equipped with an in-line fuel filter. The filter should be replaced at the intervals recommended in the Periodic Maintenance Chart beginning on page 41. Your dealer can assist.

NOTE: Do not attempt to clean the fuel filter.

MAINTENANCE

Engine Oil

Oil Change

1. Position the vehicle on a level surface. Set the parking brake.
2. Clean the area around the pre-filter plug.
3. Start the engine. Allow it to idle for two to three minutes.
4. Stop the engine.



Hot oil can cause burns to skin. Do not allow hot oil to contact skin.

5. Place a drain pan under the engine crankcase.
6. Remove the pre-filter plug. Allow the oil to drain completely.
7. Wash the oil pre-filter screen with solvent to remove debris. Allow the screen to air dry.

Oil Change

8. The external oil filter is located behind the driver's seat in front of the battery tray. The screw on the oil filter should be replaced when oil is changed. With the oil drained from the crankcase, unscrew the oil filter and replace with a new one. Ensure that the oil filter gasket is properly seated, lubricated with oil and in good condition. Do not over tighten the oil filter.
9. Clean the pre-filter plug. Install a new sealing washer on the plug. The sealing surfaces on the plug and crankcase should be clean and free of burrs, nicks or scratches.
10. Reassemble the pre-filter screen and spring to the pre-filter plug.
11. Reinstall the pre-filter drain plug. Torque to 14 ft. lbs. (19 Nm).
12. Remove the dipstick. Add 35.5 oz. (1050 ml) of the recommended oil. Do not overfill. See the specifications section beginning on page 79 for capacities.
13. Reinstall the dipstick.

MAINTENANCE

Oil Change

14. Start the engine. Allow it to idle for one to two minutes.
15. Stop the engine and inspect for leaks.
16. Check the oil level. Add oil as needed to bring the level to the upper mark on the dipstick.
17. Dispose of used oil properly.

NOTICE: This vehicle comes with an external oil cooler for the engine. Make sure to use authentic replacements from your preferred dealer.

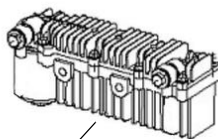

Oil Cooler

MAINTENANCE

Transmission (Main Gearcase)

Always check and change the fluid at the intervals outlined in the Periodic Maintenance Chart beginning on page 41. HAMMERHEAD recommends the use of AGL Gearcase Lubricant & Transmission Fluid for this vehicle.

Fluid Check

The fill plug is located on the rear of the gearcase. Maintain the fluid level at the bottom of the fill plug hole.

1. Position the vehicle on a level surface.
2. Remove the fill plug.
3. Check the fluid level.
4. Add the recommended fluid as needed.
5. Reinstall the fill plug.

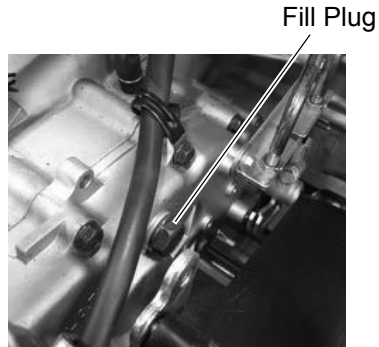

Fluid Change

The drain plug is located on the right-hand side of the transmission.

1. Remove the fill plug.
2. Place a drain pan under the drain plug.
3. Remove the drain plug. Allow the fluid to drain completely.
4. Clean the drain plug.
5. Reinstall the drain plug with a new o-ring. Torque to 14 ft. lbs. (19 Nm).
6. Refill with .75 L/25 oz of recommended gear oil. Do not overfill.
7. Reinstall the fill plug.
8. Check for leaks.
9. Discard used fluid properly.

MAINTENANCE

Drive Chain Lubrication

Lubricate the drive chain with chain spray lube or an approved chain lube at the general lubrication interval specified in the Periodic Maintenance Chart beginning on page 41. Lubricate more often under severe use, such as in dirty or wet conditions.

NOTICE: Washing the drive chain with a high pressure washer or gasoline can cause premature wear and drive chain failure. Don't use a high pressure washer or gasoline to clean the drive chain.

Adjusting or operating the vehicle with improper rear drive chain slack can result in severe damage to the transmission and drive components. Always make sure the slack is within the stated specifications.

Drive Chain Slack Adjustment

1. Loosen upper nut.
2. Turn lower nut clockwise in 1/2 turn increments, then turn upper nut until tight. Follow this procedure until chain is at proper tension. Chain should have 1/4" to 1/2" deflection.
3. Repeat the above steps until chain is adjusted to desired fit.

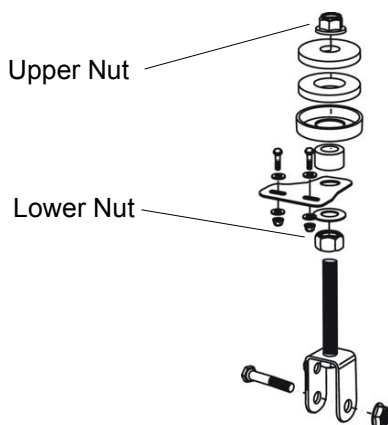

Parking Brake Adjustment

1. Inspect and perform any needed service on the brake pads before adjusting the parking brake.
2. Position the vehicle on a level surface. Place the transmission in neutral.
3. Carefully elevate the rear of the vehicle slightly. Use an appropriate lift.
4. Loosen the jam nut on the parking brake adjustment bolt.
5. While rotating the rear wheels by hand, tighten the adjustment bolt until significant brake drag is detected. Then back the adjustment bolt out 1/4 turn, or until the wheel freely spins.
6. Hold the adjustment bolt in place and tighten the jam nut securely against the lever arm.
7. Check parking brake lever movement. Verify that the rear wheels rotate freely with the parking brake off (lever in DOWN position) and that the vehicle will not move when the parking brake is applied (lever in UP position).
8. Verify that the park brake lever stays in the UP position when the brake is fully applied.



Adjustment Bolt

Parking Brake Cable Freeplay Adjustment

1. Inspect and perform any needed service on the brake pads before adjusting parking brake cable freeplay.
2. Make sure the parking brake is NOT set (lever is DOWN).
3. Pull the brake cable back to inspect freeplay between the cable end and the caliper bracket. Freeplay should be 1/16" - 1/8" (1.5-3 mm).
4. To adjust freeplay, loosen the jam nut. Turn the in-line adjustment nut outward to decrease freeplay. Turn the adjustment nut inward to increase freeplay.
5. Tighten the jam nut against the adjustment nut.



Adjustment Nut Jam Nut

MAINTENANCE

Spark Plug

Spark Plug Gap/Torque

Electrode Gap	New Plug Torque	Used Plug Torque
0.6-0.7 mm	9-11 ft. lbs. (12-15 Nm)	17-20 ft. lbs. (23-27 Nm)

NOTICE: Using non-recommended spark plugs can result in serious engine damage. Use HAMMERHEAD-recommended spark plugs or their equivalent. See page 79.

Spark plug condition is indicative of engine operation. The spark plug firing end condition should be read after the engine is warmed up and the vehicle is driven at higher speeds. Immediately check the spark plug for correct color. See page 54.



A hot exhaust system and engine can cause burns. Wear protective gloves when removing a spark plug for inspection.

Spark Plug Condition

Normal Plug

The normal insulator tip is gray, tan or light brown. There will be few combustion deposits. The electrodes are not burned or eroded. This indicates the proper type and heat range for the engine and the service.

Tip: The tip should not be white. A white insulator tip indicates overheating, caused by use of an improper spark plug or incorrect throttle body adjustments.

Wet Fouled Plug

The wet fouled insulator tip is black. A damp oil film covers the firing end. There may be a carbon layer over the entire nose. Generally, the electrodes are not worn. General causes of fouling are excessive oil, use of non-recommended injection oil or incorrect throttle body adjustments.

Spark Plug

Spark Plug Removal and Replacement

1. Use a spark plug wrench to remove the spark plug.
2. Inspect the spark plug each time you change the oil. The electrodes should be kept clean and free of carbon. The presence of carbon or excess oil will reduce proper engine performance. If possible, check the spark plug gap (area between electrodes) using a wire feeler gauge.
3. Before installing spark plug, coat threads lightly with graphite grease if possible, to ensure easy removal next time the spark plug needs inspection.
4. Reverse the procedure for spark plug installation. Torque to specification. See page 54.

NOTE: It is advisable to replace the spark plug at least once a year to insure easy starting and good engine performance.

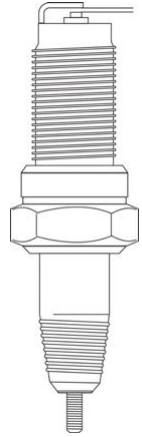

MAINTENANCE

Valve Adjustment Procedure

NOTE: In order to properly set the valves, the engine must be at TDC on the compression stroke. To find TDC on the compression stroke, roll the engine over until the intake valve closes and stop at TDC.

Intake Valve Clearance Adjustment

1. Remove the valve cover and secondary air pipr assembly.
2. Verify cam lobes are pointed down.
3. Insert correct thickness feeler gauge between end of intake valve stem and adjuster screw.
4. When clearance is correct, hold adjuster screw and tighten locknut securely.
5. Re-check the valve clearance.
6. Repeat adjustment procedure if necessary until clearance is correct with locknut secured.

MEASUREMENT

Valve Clearance
0.004" (0.10 mm)

Exhaust Valve Clearance Adjustment

1. Remove the valve cover and secondary air pipr assembly.
2. Verify cam lobes are pointed down.
3. Insert correct thickness feeler gauge between end of exhaust valve stem and adjuster screw.
4. Loosen locknut and turn adjuster screw until there is a slight drag on feeler gauge.
5. When clearence is correct, hold adjuster screw and tighten locknut securely,
6. Re-check the valve clearance.
7. Repeat adjustment procedure if necessary until clearance is correct with locknut secured.

MEASUREMENT

Valve Clearance
0.0047" (0.12 mm)

MAINTENANCE

Constant Variable Transmission (CVT) System

⚠ WARNING

Failure to comply with the instructions in this warning can result in severe injury or death.

Do not modify any component of the CVT system. Doing so may reduce its strength so that a failure may occur at a high speed. The CVT system has been precision balanced. Any modification will cause the system to be out of balance, creating vibration and additional loads on components.

The CVT system rotates at high speeds, creating large amounts of force on clutch components. Extensive engineering and testing has been conducted to ensure the safety of this product. However, as the owner, you have the following responsibilities to make sure this system remains safe:

- Always follow all recommended maintenance procedures. See your HAMMERHEAD dealer, or other qualified person, for service and repair assistance.
- This CVT system is intended for use on HAMMERHEAD products only. Do not install it in any other product.
- Always make sure the CVT housing is securely in place during operation.

CVT Drying

There may be some instances when water is accidentally ingested into the CVT system. Use the following instructions to dry it out before operating.

1. Shift the transmission to neutral. Set the parking brake.
2. Start the engine. Apply varying throttle for 10-15 seconds to expel the moisture and air-dry the belt and clutches. Do not hold the throttle wide open for more than 10 seconds.
3. Allow the engine RPM to settle to idle speed.
4. Test for belt slippage. If the belt slips, repeat the process.
5. Your vehicle requires service as soon as possible. Your HAMMERHEAD dealer can assist.

NOTICE: Exposure to salt water will cause corrosion to metal components. If your vehicle is operated in salt water areas, rinse it off frequently with fresh water.

MAINTENANCE

Filter Systems

Air Filter

Always change the air filter at the intervals outlined in the Periodic Maintenance Chart beginning on page 41.

1. The air filter box must be completely removed to access the air filter. To remove, loosen the two (2) bolts securing the box to the frame, as well as the attached intake clamp.



Bolt

1. Pull air filter box away from the machine.
2. Loosen the five (5) screws on the outside of the air filter box and remove the air filter.
3. Remove the air cleaning element.
4. Remove and replace paper filter.
5. Apply a commercially available chassis lubricant to the inside lip of the new air filter. Install the filter and tighten the clamp.

NOTICE: Never operate the vehicle with the filter element removed. Dirt will enter the engine, causing rapid wear and severe damage to the engine.

6. Reinstall the access cover.



Intake Clamp

Throttle System

⚠ WARNING

Failure to check or maintain proper operation of the throttle system can result in an accident and lead to serious injury or death if the throttle pedal sticks during operation.

Never start or operate this vehicle if it has a sticking or improperly operating throttle pedal. Immediately contact your HAMMERHEAD dealer or other qualified person for service if throttle problems arise. Always check the pedal for free movement and return before starting the engine and occasionally during operation.

Throttle Freeplay

If the throttle pedal has excessive play due to cable stretch or misadjustment, it will cause a delay in throttle response, especially at low engine speed. The throttle may also not open fully. If the throttle pedal has no freeplay, the throttle may be hard to control, and the idle speed may be erratic.

Check the throttle pedal freeplay at the intervals outlined in the Periodic Maintenance Chart beginning on page 41. Adjust the freeplay if necessary.



Brake
Pedal

Throttle
Pedal

Throttle Freeplay Inspection

1. Place the transmission in neutral. Set the parking brake.
2. Start the engine. Allow it to warm up thoroughly.
3. Measure the distance the throttle pedal moves before the engine begins to pick up speed.

MAINTENANCE

Throttle System

Throttle Freeplay Adjustment

Access the throttle cable adjuster through the right front wheel well.

1. Slide the cable adjuster boot off the cable adjuster.
2. Squeeze the end of the rubber boot and slide it far enough to expose the end of the in-line cable adjuster.
3. Loosen the adjuster lock nut.
4. Move the cable adjuster until desired freeplay is achieved at the throttle pedal. See page 59. While adjusting, lightly flip the throttle pedal up and down.
5. Tighten the lock nut.
6. Apply a small amount of grease to the inside of the boot and slide it over the cable adjuster to its original position.

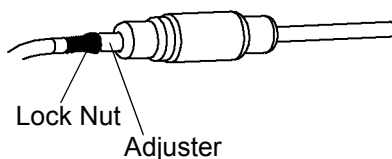
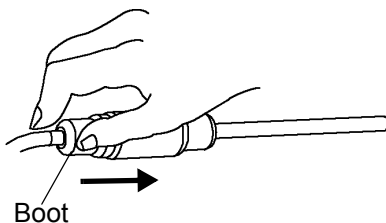

Brakes

The front and rear brakes are hydraulic disc type brakes activated by the brake pedal. See page 25.

Always check brake pedal travel and the brake fluid reservoir level before each use of the vehicle. When applied, the brake pedal should feel firm. Any sponginess would indicate a possible fluid leak or low brake fluid level, which must be corrected before riding. See page 62 for brake fluid information.

If you discover any irregularities in brake system operation, including excessive pedal travel, contact your dealer for proper diagnosis and repairs.

⚠ Operating the vehicle with a spongy brake pedal can result in loss of braking, which could cause an accident resulting in severe injury or death. Never operate the vehicle with a spongy-feeling brake pedal.

Brake Inspection

1. Check the brake system for fluid leaks.
2. Check the brake pedal for excessive travel or a spongy feel.
3. Check the brake pads for wear, damage and looseness.
4. Inspect the brake pad wear surface for excessive wear.
5. Change pads when the friction material is worn to 0.04" (1 mm).
6. Check the surface condition of the brake discs. Measure the thickness of the front and rear discs. Replace a disc if the thickness is less than 1" (2.5 mm).
7. Check brake system hoses and fittings for cracks, deterioration, abrasion and leaks. Tighten any loose fittings and replace any worn or damaged parts.

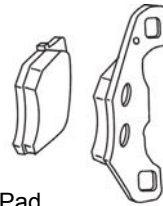

Brake Pad

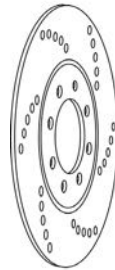

Rear Disc

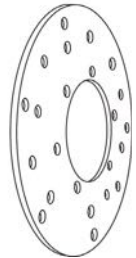

Front Disc

MAINTENANCE

Brakes

Brake Fluid

Inspect the level of the brake fluid before each operation. If the fluid level is low add DOT 4 brake fluid only. See page 90 for the part numbers of HAMMERHEAD products.

⚠ After opening a bottle of brake fluid, always discard any unused portion. Never store or use a partial bottle. Brake fluid is hygroscopic, meaning it rapidly absorbs moisture from the air. The moisture causes the boiling temperature of the brake fluid to drop, which can lead to early brake fade and the possibility of accident or severe injury.

Change the brake fluid every two years and any time the fluid becomes contaminated, the fluid level is below the minimum, or if the type and brand of the fluid in the reservoir are unknown.

Access the brake fluid reservoir through the front of the vehicle, near the left headlamp.

1. Position the vehicle on a level surface.
2. Place the transmission in neutral. Set the parking brake.
3. View the brake fluid level in the reservoir. The level should be between the maximum and minimum level lines. Add brake fluid as needed.
4. Apply the brake forcefully for a few seconds and check for fluid leakage around the fittings.

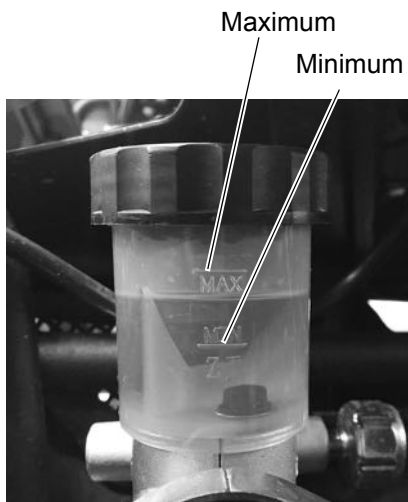

Steering Wheel Inspection

Check the steering wheel for specified freeplay and smooth operation at the intervals outlined in the Periodic Maintenance Chart beginning on page 41.

1. Position the vehicle on level ground.
2. Lightly turn the steering wheel left and right.
3. If there is excessive freeplay or strange noises, or the steering feels rough or “catchy,” have the steering system inspected by an authorized HAMMERHEAD dealer or other qualified service facility before operating the vehicle.

Shock Spring Adjustment

The front and rear shock absorber springs are adjustable to increase or decrease spring tension. There are five (5) adjustable positions on each shock.

Use a round nut wrench to rotate the adjuster to make adjustments. The tension of the shock spring will increase when turned left, and decrease when turned right. Adjust according to weight of the rider.

WARNING! Uneven adjustment may cause poor handling of the vehicle, which could result in an accident. Always adjust both the left and right spring preloads equally. Your dealer can assist.



Adjuster

MAINTENANCE

Toe Alignment

Use the following procedure to check the toe alignment of the vehicle. The recommended toe alignment is 1/8" to 1/4" (3-6 mm) toe out.

WARNING! Severe injury or death can result from improper toe alignment and adjustment. Do not attempt to adjust tie rod alignment. All tie rod adjustments should be performed by an authorized HAMMERHEAD dealer or other qualified service facility.

1. Position the vehicle on a level surface.
2. Set the steering wheel in a straight-ahead position and secure them in this position.
3. Place a chalk mark on the center line of the front tires as close to the hub/axle center line as possible. Make sure both marks are the same distance from the floor.
4. Measure the distance between the marks and record the measurement.
5. Move the vehicle to rotate the tires 180°. Position the wheels with the chalk marks at the rear of the tires, even with the hub/axle center line.
6. Measure the distance between the marks and record the measurement.
7. Subtract the front dotted line from the back dotted line. The difference is the vehicle toe-out alignment.
8. If you discover improper alignment, your preferred dealer can assist.



Tires

⚠ WARNING

Operating your vehicle with worn tires will increase the possibility of skidding, loss of control and an accident, which could result in serious injury or death. Always replace tires when the tread depth measures 1/8" (3 mm) or less.

Improper tire inflation or the use of non-standard size or type of tires may adversely affect vehicle handling, which could result in vehicle damage or personal injury. Always maintain proper tire pressure. Always use HAMMERHEAD-approved size and type of tires for this vehicle when replacing tires.

Tire Tread Depth

Always replace tires when tread depth is worn to 1/8" (3 mm) or less.

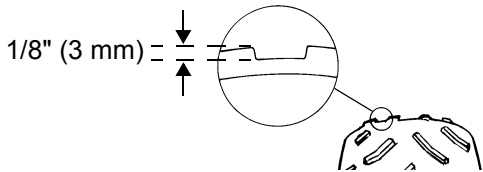

Front Wheel Hub Tightening

Front wheel bearing tightness and spindle nut retention are critical component operations. All service must be performed by your authorized HAMMERHEAD dealer or other qualified service facility.

Front Wheel Replacement

1. Position the vehicle on a level surface.
2. Place the transmission in neutral. Set the parking brake. Stop the engine.
3. Loosen the wheel nuts slightly.
4. Elevate the side of the vehicle by placing a suitable stand under the frame.
5. Remove the wheel nuts.
6. Remove the wheel.
7. Reverse steps to install.

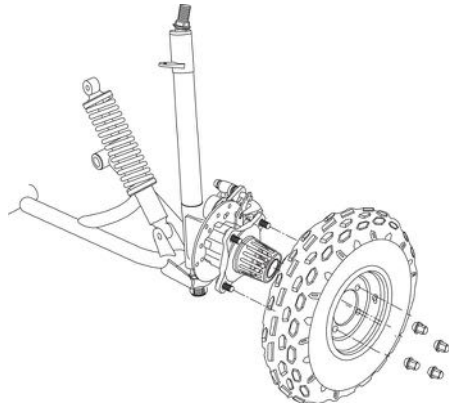

MAINTENANCE

Tires

Rear Wheel Replacement

NOTE: Do not disassemble the castle nuts when you replace the rear wheel and hub assembly.

1. Position the vehicle on a level surface.
2. Place the transmission in neutral. Set the parking brake. Stop the engine.
3. Remove the cotter pin and then 16mm nut.
4. Slide off wheel and hub assembly. It is only necessary to remove the 4 lug nuts to remove the wheel by itself.

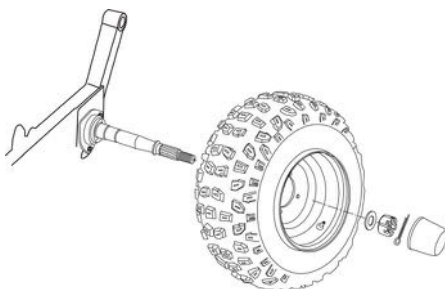

! Improperly installed wheels can adversely affect tire wear and vehicle handling, which can result in serious injury or death. Always ensure that all nuts are torqued to specification. Do not service axle nuts that have a cotter pin installed. Your HAMMERHEAD dealer can assist.

Wheel Nut Torque Specifications

Check the wheel nut torques occasionally and when they've been loosened for service.

Location	Nut Torque
Front Wheel	45 ft-lbs +/- 5 ft-lbs (61 +/- 6.8 Nm)
Rear Wheel	45 ft-lbs +/- 5 ft-lbs (61 +/- 6.8 Nm)

Lights

Headlamp Replacement

If the headlamps do not operate, replace the light assembly. Your dealer can assist.

Tail Light Lamp Replacement

If the brakelight doesn't work, the lamp may need to be replaced.

1. Remove the two screws securing the lens cover.
2. Remove the lens cover.
3. Remove the lamp and replace it with a new recommended lamp.
4. Test the light for proper operation.
5. Reinstall the lens cover.



MAINTENANCE

Vehicle Immersion

NOTICE: If your vehicle becomes immersed, major engine damage can result if the machine is not thoroughly inspected. Take the vehicle in for service before starting the engine. Your HAMMERHEAD dealer can assist.

If it's impossible to take your vehicle to a dealer before starting it, follow the steps outlined below.

1. Move the vehicle to dry land.
2. Check the air box. If water is present, dry the air box and replace the filter with a new filter. Thoroughly dry the air pre-filter. See page 58.
3. Remove the air box drain plug to drain any water. Reinstall the drain plug securely.
4. Remove the spark plug.
5. Loosen carburetor drain screw.
6. Turn the engine over several times using the electric start.
7. Re-tighten the carburetor drain screw.
8. Dry the spark plug and reinstall it, or install a new plug.
9. Attempt to start the engine. If necessary, repeat the drying procedure.
10. Take the vehicle in for service as soon as possible, whether you succeed in starting it or not. Your HAMMERHEAD dealer can provide the required service.
11. If water has been ingested into the transmission follow the procedure on page 57 for drying.

Battery

⚠ WARNING

Improperly connecting or disconnecting battery cables can result in an explosion and cause serious injury or death. When removing the battery, always disconnect the negative (black) cable first. When reinstalling the battery, always connect the negative (black) cable last.

⚠ WARNING

Battery electrolyte is poisonous. It contains sulfuric acid. Serious burns can result from contact with skin, eyes or clothing.

Antidote:

External: Flush with water.

Internal: Drink large quantities of water or milk. Follow with milk of magnesia, beaten egg, or vegetable oil. Call physician immediately.

Eyes: Flush with water for 15 minutes and get prompt medical attention.

Batteries produce explosive gases. Keep sparks, flame, cigarettes, etc. away. Ventilate when charging or using in an enclosed space. Always shield eyes when working near batteries. **KEEP OUT OF REACH OF CHILDREN.**

Your vehicle may have either a sealed battery, which requires little maintenance, or a conventional battery. A sealed battery can be identified by its flat covers on the top of the battery. A conventional battery has six filler caps on the top of the battery.

Always keep battery terminals and connections free of corrosion. If cleaning is necessary, remove the corrosion with a stiff wire brush. Wash with a solution of one tablespoon baking soda and one cup water. Rinse well with tap water and dry off with clean shop towels. Coat the terminals with dielectric grease or petroleum jelly. Be careful not to allow cleaning solution or tap water into a conventional battery.

MAINTENANCE

Battery

Battery Removal

1. The battery can be accessed from the rear of the vehicle, behind the driver's seat. Remove strap and battery cover.
2. On conventional batteries, remove the battery vent tube (sealed batteries do not have a vent tube).
3. Disconnect the negative battery cable (green) first.
4. Disconnect the positive (red) battery cable last.
5. Lift the battery out of the vehicle. Be careful not to tip a conventional battery sideways, which could spill electrolyte.



NOTICE: If electrolyte spills, immediately wash it off with a solution of one tablespoon baking soda and one cup water to prevent damage to the vehicle.

Battery Installation

Using a new battery that has not been fully charged can damage the battery and result in a shorter life. It can also hinder vehicle performance. Follow the battery charging instructions on page 78 before installing the battery.

1. Ensure that the battery is fully charged.
2. Place the battery in the battery holder.
3. Coat the terminals with dielectric grease or petroleum jelly.
4. Connect and tighten the red (positive) cable first.
5. Connect and tighten the black (negative) cable last.
6. Verify that cables are properly routed.
7. Put battery cover back on, and reattach strap.

Battery

Battery Storage

Whenever the vehicle is not used for a period of three months or more, remove the battery from the vehicle, ensure that it's fully charged, and store it out of the sun in a cool, dry place. Check battery voltage each month during storage and recharge as needed to maintain a full charge. See page 78.

Tip: Battery charge can be maintained by using a Battery Tender charger or by charging about once a month to make up for normal self-discharge. Battery Tender can be left connected during the storage period, and will automatically charge the battery if the voltage drops below a pre-determined point. See page 90 for the part numbers of HAMMERHEAD products.

Battery Charging

The following battery charging instructions apply only to the installation of a sealed battery. Read all instructions before proceeding with the installation of this battery.

The sealed battery is already filled with electrolyte and has been sealed and *fully charged* at the factory. *Never* pry the sealing strip off or add any other fluid to this battery.

The single most important thing about maintaining a sealed battery is to keep it fully charged. Since the battery is sealed and the sealing strip cannot be removed, you must use a voltmeter or multimeter to measure DC voltage.

 An overheated battery may explode, causing severe injury or death. Always watch charging times carefully. Stop charging if the battery becomes very warm to the touch. Allow it to cool before resuming charging.

For a refresh charge, follow all instructions carefully.

1. Check the battery voltage with a voltmeter or multimeter. A fully charged battery will register 12.8 V or higher.
2. If the voltage is less than 12.8 volts, recharge the battery at 1.2 amps or less until battery voltage is 12.8.

Tip: When using an automatic charger, refer to the charger manufacturer's instructions for recharging. When using a constant current charger, use the guidelines on the next page for recharging.

MAINTENANCE

Battery

Battery Charging

Always verify battery condition before and 1-2 hours after the end of charging.

State of Charge	Voltage	Action	Charge Time (Using constant current charger @ standard amps specified on top of battery)
100%	12.8-13.0 volts	None, check at 3 mos. from date of manufacture	None required
75%-100%	12.5-12.8 volts	May need slight charge, if no charge given, check in 3 months	3-6 hours
50%-75%	12.0-12.5 volts	Needs charge	5-11 hours
25%-50%	11.5-12.0 volts	Needs charge	At least 13 hours, verify state of charge
0%-25%	11.5 volts or less	Needs charge with desulfating charger	At least 20 hours

Cleaning and Storage

Washing the Vehicle

Keeping your HAMMERHEAD vehicle clean will not only improve its appearance but it can also extend the life of various components.

Before washing the vehicle, locate the CVT inlet and outlet ducts. Avoid spraying water directly toward the ducts.

NOTICE: Water in the CVT system could cause the drive belt to become wet and slip in the clutches. Always avoid spraying water directly toward the CVT inlet and outlet ducts.

High water pressure may damage components. HAMMERHEAD recommends washing the vehicle by hand or with a garden hose, using mild soap.

Certain products, including insect repellents and chemicals, will damage plastic surfaces. Do not allow these types of products to contact the vehicle.

The best and safest way to clean your HAMMERHEAD vehicle is with a garden hose and a pail of mild soap and water.

1. Use a professional-type washing cloth, cleaning the upper body first and the lower parts last.
2. Rinse with clean water frequently.
3. Dry surfaces with a chamois to prevent water spots.

Washing Tips

- Avoid the use of harsh cleaners, which can scratch the finish.
- Do not use a power washer to clean the vehicle.
- Do not use medium to heavy duty compounds on the finish.
- Always use clean cloths and pads for cleaning and polishing. Old or reused cloths and pads may contain dirt particles that will scratch the finish.

MAINTENANCE

Cleaning and Storage

Washing the Vehicle

If a high pressure water system is used for cleaning (not recommended), exercise extreme caution. The water may damage components and could remove paint and labels. Avoid directing the water stream at the following items:

- Wheel bearings
- Radiator
- Transmission seals
- CVT inlet and outlet ducts
- Brakes
- Cab and body panels
- Labels and decals
- Electrical components and wiring

If an informational or graphic label becomes illegible or comes off, contact your HAMMERHEAD dealer to purchase a replacement. Replacement *safety* labels are provided by HAMMERHEAD at no charge.

Grease all zerk fittings immediately after washing. Allow the engine to run for a while to evaporate any water that may have entered the engine or exhaust system.

Polishing the Vehicle

HAMMERHEAD recommends the use of common household aerosol furniture polish for polishing the finish on your HAMMERHEAD vehicle. Follow the instructions on the container.

Polishing Tips

- Avoid the use of automotive products, some of which can scratch the finish of your vehicle.
- Always use clean cloths and pads for cleaning and polishing. Old or reused cloths and pads may contain dirt particles that will scratch the finish.

Cleaning and Storage

Chrome Wheel Care (if equipped)

Proper maintenance will protect chrome wheels from corrosion, preserve wheel life and ensure a “like new” appearance for many years.

Tip: Chrome wheels exposed to road salt (or salt in the air in coastal areas) are more susceptible to corrosion if not properly cleaned. Clean chrome wheels more often if they're exposed to salt or other corrosive elements.

1. Wash chrome wheels frequently. Use a mild detergent. Never use abrasive cleaners on plated or painted surfaces.
2. Rinse well with clear water. Soap, detergents, salt, dirt, mud and other elements can cause corrosion.
3. Polish the clean chrome wheels periodically. Use an automotive grade chrome polish.
4. Routinely and liberally apply a weather resistant wax to each polished chrome wheel. Choose a product suitable for chrome finishes. Read and follow the product labels and instructions.

Removing Corrosion

If light rust is found on the chrome finish, use steel wool (#0000-OTT grade) to remove it. Gently rub the affected areas with the steel wool until the corrosion has been removed. Clean and polish the wheel as outlined above.

MAINTENANCE

Cleaning and Storage

Storage Tips

NOTICE: Starting the engine during the storage period will disturb the protective film created by fogging and damage could occur. Never start the engine during the storage period.

Clean the Exterior

Make any necessary repairs and clean the vehicle as recommended. See page 73.

Stabilize the Fuel

1. Fill the fuel tank.
2. Add Carbon Clean Fuel Treatment or equivalent fuel treatments or stabilizers. Follow the instructions on the container for the recommended amount. Carbon Clean removes water from fuel systems, stabilizes fuel and removes carbon deposits from pistons, rings, valves and exhaust systems.
3. Allow the engine to run for 15-20 minutes in a well ventilated area to allow the stabilizer to disperse through the entire fuel delivery system.

Air Filter / Air Box

Inspect and clean or replace the air filter. See page 58. Clean the air box. Drain the sediment tube.

Fluid Levels

Inspect the fluid levels. Add or change fluids as recommended in the Periodic Maintenance Chart beginning on page 41.

- Transmission fluid
- Brake fluid (change every two years and any time the fluid looks dark or contaminated)

Engine Oil

Change the oil. See page 48.

Cleaning and Storage

Storage Tips

Inspect and Lubricate

Inspect all cables and lubricate all areas of the vehicle as recommended in the Periodic Maintenance Chart beginning on page 41.

Fog the Engine

1. Treat the fuel system with Carbon Clean or other equivalent fuel treatment. Follow the instructions on the container. Start the engine. Allow it to idle for several minutes so the Carbon Clean reaches the carburetor. Stop the engine.
2. Remove the spark plug and add 2-3 tablespoons of engine oil. To access the plug hole, use a section of clear 1/4" hose and a small plastic squeeze bottle filled with the pre-measured amount of oil.
3. Reinstall the spark plug. Torque to specification. See page 54.
4. Apply dielectric grease to the inside of the spark plug cap. *Do not reinstall the cap onto the plug at this step.*
5. Turn the engine over several times. Oil will be forced in and around the piston rings and ring lands, coating the cylinder with a protective film of fresh oil.
6. If fuel system additive is not used, fuel tank, fuel lines, and injectors should be completely drained of gasoline.
7. Reinstall the spark plug cap to the spark plug.

Battery Maintenance

See pages 71-72 for storage and charging procedures.

Storage Area/Covers

Be sure the storage area is well ventilated. Do not use plastic or coated materials. They do not allow enough ventilation to prevent condensation, and may promote corrosion and oxidation.

MAINTENANCE

Cleaning and Storage

Removal from Storage

1. Check the battery electrolyte level and charge the battery if necessary. Install it in the vehicle. Make sure the battery vent hose is routed properly and that it's not pinched or restricted in any way.
2. Make sure the spark plug is tight.
3. Fill the fuel tank with fuel.
4. Check all the points listed in the Daily Pre-Ride Inspection section on page 28. Tightness of the bolts, nuts and other fasteners should be checked by an authorized HAMMERHEAD dealer or other qualified service facility.
5. Lubricate at the intervals outlined in the Periodic Maintenance Chart beginning on page 41.

Transporting the Vehicle

Follow these procedures when transporting the vehicle.

1. Place the transmission in neutral. Set the parking brake.
2. Stop the engine.
3. Remove the key to prevent loss during transporting.
4. Secure the fuel cap and seats. Ensure that the seats are attached correctly and are not loose.

NOTICE: Always tie the frame of the HAMMERHEAD vehicle to the transporting unit securely with suitable straps or rope. Do not attach tie straps to the front control arm bolt pockets.

5. Wrap the front tie strap through the frame tubes, or attach a tie-down hook around each of the tubes.
6. Wrap the rear tie strap around the swing arm.

SPECIFICATIONS

R 150

Engine	Engine/Motor Type	4-Stroke
	Displacement	149cc
	Cooling	Air
	Starting	Electric
	Fuel System	Carburetor
	Fuel Capacity	1.75 Gal
	Fuel Type	Unleaded. Never use fuel with higher than 10% ethanol.
	Engine Oil Capacity	35.5 oz. (1050 ml)
	Engine Oil Type	SAE-10W/40
	Spark Plug Type	CR7HSA (NGK)
Drivetrain	Drive/Clutch	Automatic CVT
	Drive Type	2-Wheel Drive
	Transmission/Transaxle	F/N/R
	Driveline	Dual Chain
Chassis	Front Suspension	Dual A-Arm
	Rear Suspension	Swing Arm
	Steering	Rack & Pinion
	Front Brake	Hydraulic Disc (2)
	Rear Brake	Hydraulic Disc
	Seats	Bench
	Seat belt	3-Point Harness
Tires	Body	Brush Guard
	Front Tires	22x7-10
	Rear Tires	22x10-10
	Wheels	Steel (Black)
	Operating Tire Pressure Front	10 PSI
Operating Tire Pressure Rear	10 PSI	

SPECIFICATIONS

R 150		
Dimensions	Length	95"
	Width	51"
	Height	74"
	Wheelbase	67"
	Ground Clearance	6.5"
	Bed/Rack Dimensions L x W x H	38" x 23" x 11"
	Distance Seat to Pedal (Front Edge)	N/A
	Distance Seat to Pedal (Seat Back)	N/A
Capacity	Bed/Rack Capacity	250 lbs
	Towing Capacity	500 lbs
	Vehicle Capacity	800 lbs
	Fuse	15A
	Battery	12V / 9 Amp Hours
Weight	Dry Weight	700 lbs

SPECIFICATIONS

ENGINE TUNE-UP SPECIFICATION

Idle Mixture	Non-Adjustable
Intake Valve Clearance	0.04" (0.1 mm)
Exhaust Valve Clearance	0.0047" (0.12 mm)
Spark Plug	CR7HSA (NGK)
Spark Plug Gap	0.6 - 0.7 mm
Ignition Timing	Non-Adjustable
Idle Speed	1700 +/- 100 RPM in Neutral
Fuel	Unleaded Gasoline Only 87 (R+M)/2 Octane or Higher
Oil	10W 40

SPECIFICATIONS

Jetting Chart

Carburetor Jetting									
Carburetor Jetting Chart for Altitude and Ambient Temperature Changes									
ALTITUDE Feet (Meters)	AMBIENT TEMPERATURE								
	°F:	Below -25	-30 to -10	-15 to +5	0 to +20	+15 to +35	+30 to +50	+45 to +65	Above +60
	°C:	Below -31	-34 to -23	-26 to -15	-18 to -7	-9 to +2	-1 to +10	+7 to +18	Above +16
0-2000 (0-600)	Main Jet	112	112	112	112	111	111	111	111
	Pilot Jet	38	38	38	38	35	35	35	35
	Needle	2 shims	2 shims	2 shims	2 shims	1 shim	1 shim	1 shim	1 shim
2000-4000 (600-1200)	Main Jet	112	112	112	112	111	111	111	111
	Pilot Jet	38	38	38	38	35	35	35	35
	Needle	2 shims	2 shims	2 shims	2 shims	1 shim	1 shim	1 shim	1 shim
4000-6000 (1200-1800)	Main Jet	111	111	111	111	110	110	110	110
	Pilot Jet	35	35	35	35	35	35	35	35
	Needle	1 shim	1 shim	1 shim	1 shim	1 shim	1 shim	1 shim	1 shim
6000-8000 (1800-2400)	Main Jet	111	111	111	111	110	110	110	110
	Pilot Jet	35	35	35	35	32	32	32	32
	Needle	1 shim	1 shim	1 shim	1 shim	No shim	No shim	No shim	No shim
8000-10000 (2400-3000)	Main Jet	110	110	110	110	109	109	109	109
	Pilot Jet	35	35	35	35	32	32	32	32
	Needle	1 shim	1 shim	1 shim	1 shim	No shim	No shim	No shim	No shim
Above 10000 (Above 3000)	Main Jet	110	110	110	110	109	109	109	109
	Pilot Jet	35	35	35	35	32	32	32	32
	Needle	1 shim	1 shim	1 shim	1 shim	No shim	No shim	No shim	No shim

TROUBLESHOOTING

Drive Belt Wear/Burn

Possible Cause	Solution
Driving at low RPM or ground speed	Drive at a higher speed.
Insufficient warm-up at low ambient temperatures	Warm the engine at least 5 minutes. With the transmission in neutral, apply small amount of throttle in short bursts, 5 to 7 times. The belt will become more flexible and prevent belt burning.
Slow/easy clutch engagement	Use the throttle quickly and effectively.
Belt slippage from water or snow ingestion into the CVT system	Dry out the CVT (see page 57). <i>Prevent water from entering the CVT inlet and outlet ducts (see page 73).</i> Inspect clutch seals for damage if repeated leaking occurs.
Clutch malfunction	Your HAMMERHEAD dealer can assist.
Poor engine performance	Check for fouled plug or foreign material in gas tank, fuel filter, and fuel lines. Your HAMMERHEAD dealer can assist.
Wrong or missing belt	Install the recommended belt.
Improper break-in	Always break in a new belt and/or clutch. See page 26.

TROUBLESHOOTING

Engine Doesn't Turn Over

Possible Cause	Solution
Low battery voltage	Recharge the battery to 12.8 VDC
Loose battery connections	Check all connections and tighten
Loose solenoid connections	Check all connections and tighten

Engine Turns Over, Fails to Start

Possible Cause	Solution
Out of fuel	Refuel
Water is present in fuel	Drain the fuel system and refuel
Old or non-recommended fuel	Replace with fresh recommended fuel
Fouled or defective spark plug	Inspect plug and replace if necessary
No spark to spark plug	Inspect plug and replace if necessary
Water or fuel in crankcase	Your HAMMERHEAD dealer can assist.
Clogged fuel filter	Inspect plug and replace if necessary
Low battery voltage	Recharge the battery to 12.8 VDC
Mechanical failure	Your HAMMERHEAD dealer can assist.

Engine Backfires

Possible Cause	Solution
Weak spark from spark plug	Inspect, clean and/or replace spark plug
Incorrect spark plug gap or heat range	Set gap to specs or replace plug
Old or non-recommended fuel	Replace with fresh recommended fuel
Incorrectly installed spark plug wires	Your HAMMERHEAD dealer can assist.
Incorrect ignition timing	Your HAMMERHEAD dealer can assist.
Mechanical failure	Your HAMMERHEAD dealer can assist.
Loose ignition connections	Check all connections and tighten
Water present in fuel	Replace with fresh recommended fuel
Exhaust system leak	Your HAMMERHEAD dealer can assist.

TROUBLESHOOTING

Engine Pings or Knocks

Possible Cause	Solution
Poor quality or low octane fuel	Replace with recommended fuel
Incorrect ignition timing	Your HAMMERHEAD dealer can assist.
Incorrect spark plug gap or heat range	Set gap to specs or replace plug

Engine Runs Irregularly, Stalls or Misfires

Possible Cause	Solution
Fouled or defective spark plug	Inspect, clean and/or replace spark plug
Worn or defective spark plug wires	Your HAMMERHEAD dealer can assist.
Incorrect spark plug gap or heat range	Set gap to specs or replace plug
Loose ignition connections	Check all connections and tighten
Water present in fuel	Replace with new fuel
Low battery voltage	Recharge battery to 12.8 VDC
Clogged fuel cap vent	Inspect and replace
Incorrect fuel	Replace with recommended fuel
Clogged air filter	Inspect and clean or replace
Throttle control malfunction	Your HAMMERHEAD dealer can assist.
Other mechanical failure	Your HAMMERHEAD dealer can assist.

Possible Lean Fuel Cause	Solution
Low or contaminated fuel	Add or change fuel, clean the fuel system
Low octane fuel	Replace with recommended fuel
Clogged fuel filter	Your HAMMERHEAD dealer can assist.
Incorrect fuel	Replace with recommended fuel

Possible Rich Fuel Cause	Solution
Fuel is very high octane	Replace with lower octane fuel
Stopping/starting without adequate warm-up	Allow engine to warm up before operating and/or stopping
Incorrect fuel	Replace with recommended fuel
Clogged air filter	Inspect and clean or replace
Incorrect jetting	
Overuse of choke	

TROUBLESHOOTING

Engine Stops or Loses Power

Possible Cause	Solution
Out of fuel	Refuel
Clogged fuel cap vent	Inspect and replace
Water is present in fuel	Replace with new fuel
Fouled or defective spark plug	Inspect, clean and/or replace spark plug
Worn or defective spark plug wires	Your HAMMERHEAD dealer can assist.
Incorrect spark plug gap or heat range	Set gap to specs or replace plug
Loose ignition connections	Check all connections and tighten
Low battery voltage	Recharge the battery to 12.8 VDC
Incorrect fuel	Replace with fresh recommended fuel
Clogged air filter	Inspect and clean or replace
Throttle control malfunction	Your HAMMERHEAD dealer can assist.
Other mechanical failure	Your HAMMERHEAD dealer can assist.

WARRANTY

Limited Warranty

HAMMERHEAD Inc., 1200 Lakeside Parkway Ste. 400 Flower Mound, TX 75028 (HAMMERHEAD) provides a ONE HUNDRED and EIGHTY DAY PARTS ONLY LIMITED WARRANTY against defects in material or workmanship for all vehicle frames and engines. This PARTS ONLY LIMITED WARRANTY covers parts charges for repair or replacement of defective parts but does not cover any related labor charges or expense.

HAMMERHEAD provides a NINETY DAY PARTS AND LABOR LIMITED WARRANTY against defects in material or workmanship for all other components, except those consumable, general wear, and exposed to friction components referenced in the following paragraph. This NINETY DAY LIMITED WARRANTY covers parts and labor charges for repair or replacement of defective parts.

HAMMERHEAD provides a THIRTY DAY LIMITED WARRANTY against defects in material or workmanship on all consumable components, general wear items, or any parts exposed to friction surfaces, stresses, environmental conditions and/or contamination for which they were not designed or not intended; including but not limited to the following items:

- Wheels and Tires
- Suspension Components
- Brake Components
- Seat Components
- Clutches and Components
- Steering Components
- Batteries
- Light Bulbs/ Sealed Beam Lamps
- Filters
- Lubricants
- Bushings
- Cables
- Finished and Unfinished Surfaces
- Carburetor/Throttle Body Components
- Engine Components
- Drive Belts
- Hydraulic Components and Fluids
- Circuit Breakers/Fuses
- Electronic Components
- Spark Plugs
- Sealants
- Coolants
- Bearings
- Vehicle Tops

This THIRTY DAY LIMITED WARRANTY covers parts and labor charges for repair or replacement of defective parts.

The duration of these warranties may vary by international region based upon local laws and regulations. These warranties begin on the date of purchase by the original retail purchaser.

Registration

IMPORTANT!

ALL UNITS MUST BE REGISTERED WITHIN 14 DAYS OF PURCHASE.

To register your product a copy of the Warranty Registration Form and sales receipt must be forwarded to HAMMERHEAD Off-Road. Your dealer, with your assistance, will complete and forward these items to HAMMERHEAD Off-Road. A copy of the Warranty Registration Card and Buyer Safety Agreement is attached. It is your responsibility to confirm with your dealer within 14 days of purchase that your product has been registered. If you are unable to confirm with your dealer within 14 days of purchase that your product has been registered please contact HAMMERHEAD Off-Road within 14 days of purchase.

WARRANTY

Warranty Coverage And Exclusions:

Limitations Of Warranties And Remedies

This HAMMERHEAD limited warranty excludes any failures that are not caused by a defect in material or workmanship. THIS WARRANTY DOES NOT COVER CLAIMS OF DEFECTIVE DESIGN. This warranty also does not cover acts of God, accidental damage, normal wear and tear, abuse or improper handling. This warranty also does not cover any vehicle, component, or part that has been altered structurally, modified, neglected, improperly maintained or used for racing, competition or purposes other than for which it was designed.

This warranty excludes damages or failures resulting from: improper lubrication; improper engine timing; improper fuel; surface imperfections caused by external stress, heat, cold or contamination; operator error or abuse; improper component alignment, tension, adjustment or altitude compensation; snow, water, dirt or other foreign substance ingestion/contamination; improper maintenance; modified components; use of aftermarket or unapproved components, accessories, or attachments; unauthorized repairs; or repairs made after the warranty period expires or by an unauthorized repair center.

This warranty excludes damages or failures caused by abuse, accident, fire, or any other cause other than a defect in materials or workmanship and provides no coverage beyond the 180, 90, or 30 day period set forth above

Lubricants and Fluids

1. Mixing oil brands or using non-recommended oil may cause engine damage.
2. Damage or failure resulting from the use of non-recommended lubricants or fluids is not covered by this warranty.

This warranty provides no coverage for personal loss or expense, including mileage, transportation costs, hotels, meals, shipping or handling fees, product pick-up or delivery, replacement rentals, loss of product use, loss of profits, or loss of vacation or personal time.

THE EXCLUSIVE REMEDY FOR BREACH OF THIS WARRANTY SHALL BE, AT HAM-MERHEAD'S OPTION, REPAIR OR REPLACEMENT OF ANY DEFECTIVE MATERIALS, COMPONENTS, OR PRODUCTS. THE REMEDIES SET FORTH IN THIS WARRANTY ARE THE ONLY REMEDIES AVAILABLE TO ANY PERSON FOR BREACH OF THIS WARRANTY. HAMMERHEAD SHALL HAVE NO LIABILITY TO ANY PERSON FOR IN-CIDENTAL, CONSEQUENTIAL OR SPECIAL DAMAGES OF ANY DESCRIPTION, WHETHER ARISING OUT OF EXPRESS OR IMPLIED WARRANTY OR ANY OTHER CONTRACT, NEGLIGENCE, OR OTHER TORT OR OTHERWISE. THIS EXCLUSION OF CONSEQUENTIAL, INCIDENTAL, AND SPECIAL DAMAGES IS INDEPENDENT FROM AND SHALL SURVIVE ANY FINDING THAT THE EXCLUSIVE REMEDY FAILED OF ITS ESSENTIAL PURPOSE.

THE IMPLIED WARRANTY OF FITNESS FOR A PARTICULAR PURPOSE IS EXCLUDED FROM THIS LIMITED WARRANTY. ALL OTHER IMPLIED WARRANTIES (INCLUDING BUT NOT LIMITED TO THE IMPLIED WARRANTY OF MERCHANTABILITY) ARE LIM-ITED IN DURATION TO THE ABOVE WARRANTY PERIODS. HAMMERHEAD DIS-CLAIMS ALL EXPRESS WARRANTIES NOT STATED IN THIS WARRANTY. SOME STATES DO NOT PERMIT THE EXCLUSION OR LIMITATION OF INCIDENTAL OR CONSEQUENTIAL DAMAGES OR ALLOW LIMITATIONS ON THE DURATION OF IM-PLIED WARRANTIES, SO THE ABOVE LIMITATIONS MAY NOT APPLY TO YOU IF IN-CONSISTENT WITH CONTROLLING STATE LAW.

How To Obtain Warranty Service

If your vehicle requires warranty service, you must take it to a HAMMERHEAD Servicing Dealer. When requesting warranty service you must present your copy of the Warranty Registration Form to the dealer. (THE COST OF TRANSPORTATION TO AND FROM THE DEALER IS YOUR RESPONSIBILITY.) HAMMERHEAD suggests that you use your original selling dealer; however, you may use any HAMMERHEAD Servicing Dealer to perform warranty service.

In the Country where your product was purchased:

Warranty or Service Bulletin repairs must be done by an authorized HAMMERHEAD dealer. If you move or are traveling within the country where your product was purchased, Warranty and Service Bulletin repairs may be requested from any authorized HAMMERHEAD dealer that sells the same line as your product.

Outside the Country where your product was purchased:

If you are traveling temporarily outside the country where your product was purchased, you should take your product to an authorized HAMMERHEAD dealer. You must show the dealer photo identification from the country of the selling dealer's authorized location as proof of residence. Upon residence verification, the servicing dealer will be authorized to perform the warranty repair.

If you move:

If you move to another country, be sure to contact HAMMERHEAD Customer Assistance and the customs department of the destination country before you move. Product importation rules vary considerably from country to country. You may be required to present documentation of your move to HAMMERHEAD in order to continue your warranty coverage. You may also be required to obtain documentation from HAMMERHEAD in order to register your product in your new country. You should warranty register your product at a local HAMMERHEAD dealer in your new country immediately after you move to continue your warranty coverage and to ensure that you receive information and notices regarding your vehicle.

If you purchase from a private party:

If you purchase a HAMMERHEAD product from a private party, to be kept and used outside of the country in which the product was originally purchased, all warranty coverage will be denied. You must nonetheless register your product under your name and address with a local HAMMERHEAD dealer in your country to ensure that you receive safety information and notices regarding your product.

Exported Products

EXCEPT WHERE SPECIFICALLY REQUIRED BY LAW, THERE IS NO WARRANTY OR SERVICE BULLETIN COVERAGE ON THIS PRODUCT IF IT IS SOLD OUTSIDE THE COUNTRY OF THE SELLING DEALER'S AUTHORIZED LOCATION. This policy does not apply to products that have received authorization for export from HAMMERHEAD. Dealers may not give authorization for export. You should consult an authorized dealer to determine this product's warranty or service coverage if you have any questions. This policy does not apply to products registered to government officials or military personnel on assignment outside the country of the selling dealer's authorized location. This policy does not apply to Safety Bulletins.

WARRANTY

Notice

If your product is registered outside of the country where it was purchased and you have not followed the procedure set above, your product will no longer be eligible for warranty or service bulletin coverage of any kind, other than safety bulletins. Products registered to government officials or military personnel on assignment outside of the country where the product was purchased will continue to be covered by the Limited Warranty.

Please work with your dealer to resolve any warranty issues. Should your dealer require any additional assistance, they will contact the appropriate person at HAMMERHEAD.

This warranty gives you specific legal rights, and you may also have other rights which vary from state to state or in different countries. If any of the above terms are void because of federal, state, local law, all other warranty terms will remain in effect.

For questions call HAMMERHEAD Customer Assistance:

United States & Canada: 214-513-1700

WARRANTY

Emissions Control System Limited Warranty

This Emissions Control System Limited Warranty for your engine is provided by Polaris Sales Inc. (PSI). It is administered by HAMMERHEAD Off-Road Inc. on behalf of PSI. This Emissions Control System Limited Warranty is in addition to the HAMMERHEAD Off-Road Inc. standard limited warranty for your vehicle. HAMMERHEAD Off-Road Inc. is hereinafter referred to as HAMMERHEAD in the remainder of this Emission Control System Limited Warranty.

YOUR WARRANTY RIGHTS AND OBLIGATIONS

Your new spark-ignited small off-road engine must be designed, built, and equipped to meet applicable U.S. EPA emission standards.

HAMMERHEAD warrants the emission control system on your small off-road engine for the 2-year period of time listed below, provided there has been no abuse, neglect, or improper maintenance of your power equipment engine. Where a warrantable condition exists, HAMMERHEAD will repair your small off-road engine at no cost to you including diagnosis, parts, and labor.

Your emission control system may include parts such as the carburetor or fuel injection system, fuel lines, hoses, connectors, the ignition system, catalytic converter, and other emissions-related assemblies (see the WARRANTY COVERAGE section below for more information on the covered parts).

OWNER'S WARRANTY RESPONSIBILITIES

Owners are responsible for performing all required maintenance identified in the owner's manual. HAMMERHEAD recommends that all receipts covering the maintenance of your small off-road engine are retained, but HAMMERHEAD cannot deny warranty solely for the lack of receipts or for your failure to ensure that all scheduled maintenance has been completed.

HAMMERHEAD may deny warranty claims for failures that have been caused by the owner's or operator's improper maintenance or use, by accidents for which HAMMERHEAD has no responsibility, or by acts of God.

You are responsible for presenting your small off road engine to a HAMMERHEAD dealer, a qualified repair shop, or qualified individual as soon as a problem exists.

For any questions regarding your warranty rights and responsibilities, contact HAMMERHEAD at the following:

Hammerhead Off-Road Inc.
1200 Lakeside Parkway #400
Flower Mound, TX 75028
Telephone: 214-513-1700
Fax: 214-513-1711
Email: mail@hammerheadoffroad.com

WARRANTY

Emissions Control System Limited Warranty

WARRANTY COVERAGE

HAMMERHEAD warrants to the ultimate purchaser and each subsequent purchaser that, at the time it is first purchased, this emissions-certified engine is designed, built, and equipped so it conforms to applicable U.S. Environmental Protection Agency emission regulations. HAMMERHEAD warrants that the engine is free from defects in materials and workmanship that would cause it to fail to meet these regulations.

The emissions control system of your engine is covered by this warranty for a period of two years, beginning on the date the engine or small-off road vehicle equipped with the engine is sold to the ultimate purchaser. This warranty is transferable to each subsequent purchaser for the duration of the warranty period. This EPA emissions warranty period is extended for at least as long as the standard factory warranty that HAMMERHEAD provides on the engine as a whole. The EPA emissions warranty period does not further extend if additional warranty coverage in the form of a service contract or other paid warranty extension is purchased, but emission-related parts may be covered subject to the terms of any such paid service contract or paid warranty extension.

This emissions limited warranty covers components whose failure increases the vehicle's regulated emissions, and it covers components of systems whose only purpose is to control emissions. Repairing or replacing other components not covered by this warranty is the responsibility of the vehicle owner. This emissions limited warranty does not cover components whose failure does not increase the vehicle's regulated emissions.

For exhaust emissions, emission-related components include any engine parts related to the following systems:

- Air-induction system
- Fuel system
- Ignition system
- Exhaust gas recirculation systems

The following parts are also considered emission-related components for exhaust emissions:

- After-treatment devices
- Crankcase ventilation valves
- Sensors
- Electronic control units

The following parts are considered emission-related components for evaporative emissions:

- Fuel Tank
- Fuel Cap
- Fuel Line
- Fuel Line Fittings
- Clamps*
- Pressure Relief Valves*
- Control Valves*
- Control Solenoids*
- Electronic Controls*
- Vacuum Control Diagrams*
- Control Cables*
- Control Linkages*
- Purge Valves
- Vapor Hoses
- Liquid/Vapor Separator
- Carbon Canister
- Canister Mounting Brackets
- Carburetor Purge Port Connector

*As related to the evaporative emission control system.

If any emissions related component on your engine is defective, HAMMERHEAD will repair or replace the defective component without charge for diagnosis, parts, or labor. All defective parts replaced under this warranty become the property of HAMMERHEAD.

WARRANTY

Emissions Control System Limited Warranty

EXCLUSIONS

This limited warranty excludes failures not caused by a defect in material or workmanship. This limited warranty does not cover emissions control systems or parts that are affected or damaged by owner abuse, neglect, improper maintenance, misuse, improper fueling, improper storage, collision, accidents, or improper handling. This limited warranty also does not cover any engine that has been structurally altered, or an engine that has been used in racing competition. This limited warranty also does not cover physical damage, corrosion or defects caused by fire, explosions or other similar causes beyond the control of HAMMERHEAD, or by acts of God.

TO OBTAIN WARRANTY SERVICE

The vehicle owner must, at their own expense, take the small off-road engine, or the product on which it is installed, along with the sales registration card or other proof of original purchase date, to any qualified repair shop or qualified person. A qualified party may maintain, replace, or repair the emission control devices or systems on your vehicle. An authorized HAMMERHEAD dealer can perform any service that may be necessary for your vehicle. HAMMERHEAD and authorized HAMMERHEAD dealers can provide warranty replacement parts but equivalent parts can be used for emissions-related repairs. It is a potential violation of the Clean Air Act if a part supplied by an aftermarket parts manufacturer reduces the effectiveness of the vehicle's emission controls. Tampering with emission controls is prohibited by federal law.

To receive information about how to make a warranty claim, how to make arrangements for authorized repairs, or if you are unable to obtain emission warranty service or are dissatisfied with warranty service received, please contact HAMMERHEAD for additional assistance.

Hammerhead Off-Road Inc.
1200 Lakeside Parkway #400
Flower Mound, TX 75028
Telephone: 214-513-1700

Fax: 214-513-1711

Email: mail@hammerheadoffroad.com

WARRANTY

DISCLAIMER

The exclusive remedy for breach of this limited warranty shall be, at the exclusive option of HAMMERHEAD, repair or replacement of any defective materials, components or products. THE REMEDIES SET FORTH IN THIS LIMITED WARRANTY ARE THE ONLY REMEDIES AVAILABLE TO ANY PERSON FOR BREACH OF THIS WARRANTY. HAMMERHEAD SHALL HAVE NO LIABILITY TO ANY PERSON FOR INCIDENTAL, CONSEQUENTIAL OR SPECIAL DAMAGES OF ANY DESCRIPTION, WHETHER ARISING OUT OF EXPRESS OR IMPLIED WARRANTY OR ANY OTHER CONTRACT, NEGLIGENCE OR OTHER TORT OR OTHERWISE. THIS EXCLUSION OF CONSEQUENTIAL, INCIDENTAL, AND SPECIAL DAMAGES IS INDEPENDENT FROM AND SHALL SURVIVE ANY FINDING THAT THE EXCLUSIVE REMEDY FAILED OF ITS ESSENTIAL PURPOSE.

ALL IMPLIED WARRANTIES (INCLUDING BUT NOT LIMITED TO ANY IMPLIED WARRANTIES OF MERCHANTABILITY AND FITNESS FOR A PARTICULAR PURPOSE) ARE LIMITED IN DURATION TO THE WARRANTY PERIOD DESCRIBED HEREIN. HAMMERHEAD DISCLAIMS ALL EXPRESS WARRANTIES NOT STATED IN THIS WARRANTY. Some states do not allow limitations on how long an implied warranty lasts, so the above limitation may not apply if it is inconsistent with the controlling state law.

WARRANTY

Off-Road Warranty Registration Form

Registration Terms & Conditions

In order to activate the warranty, please follow the instructions below:

1. Make a copy of the Bill of Sale.
2. Make a copy of Pre-Delivery Checklist.
3. Fill out warranty card and send with all above documents to:

Hammerhead Off-Road
Attn: Warranty Registration
1200 Lakeside Parkway Ste. 400
Flower Mound, TX 75028
Or, Fax to 214-513-1738

Or, go online to www.hammerheadoffroad.com
under dealer's only section

Hammerhead Off-Road Warranty Registration Card	
(Must be sent in with a copy of sales receipt)	
VIN# _____	Model: _____
Dealer Name: _____	
Dealer Address: _____	
City: _____	State: _____ Zip: _____
Customer Name: _____	
Customer City: _____	State: _____
Customer Phone: _____	Email: _____
Date of Purchase: _____	
I Certify that all information provided is true and correct to the best of my knowledge. I understand the exceptions and limitations of the warranty coverage.	
Customer Signature: _____	Date: _____

MAINTENANCE LOG

Use the following chart to record periodic maintenance.

DATE	MILES (KM) OR HOURS	TECHNICIAN	SERVICE PERFORMED / COMMENTS

MAINTENANCE LOG

Use the following chart to record periodic maintenance.

DATE	MILES (KM) OR HOURS	TECHNICIAN	SERVICE PERFORMED / COMMENTS

INDEX

A

Adjustment	
Steering Wheel	21
Adjustment, Throttle Freeplay	60
Air Filter	58
Air Filter Cleaning	58

B

Battery	69-72
Charging (Sealed Battery)	71-72
Battery Installation	70
Battery Removal	70
Battery Storage	71
Before Riding	28
Belt Burning	83
Belt Wear	83
Belts, Seat	21
Boots	9
Brake Adjustment, Parking	53
Brake Adjustment, Parking Brake Cable Freeplay	53
Brake Fluid	62
Brake Inspection	61
Brake Pedal	25
Brake System Break-in	27
Brakes	61-62
Braking	31
Break-In Period	26-27
Burning Belts	83

C

Cap, Fuel	25
Carburetor Jetting	82
Chart, Periodic Maintenance	41-45
Chrome Wheel Care	75
Cleaning and Storage	73-78
Cleaning the Air Filter	58
Clothing	9
Component Locations	20
Condition, Spark Plugs	54
CVT System	57
Corrosion Removal, Chrome	75
Cover for Storage	77
Crankcase Emission Control System	40
CVT Break-In	27
CVT Drying	57
CVT System	57

D

Drive Belt Wear	83
Drive Chain Lubrication	52
Drive Chain Slack Adjustment	52
Drivetrain Break-In	27
Driving Downhill	37
Driving in Reverse	38
Driving on a Sidehill	37
Driving on Slippery Surfaces	35
Driving Over Obstacles	39
Driving Procedures	32-33
Driving Through Water	38
Driving Uphill	36
Driving with a Passenger	34

E

Emission Control, Crankcase	40
Emission Control, Noise	40
Engine Break-In	27
Engine Fogging	77
Engine Oil	47-48
Engine Stopping	31
Equipment Modifications	7
Eye Protection	9

F

Filter Care During Storage	76
Filter Cleaning, Air	58
Filter Systems	58
Filter, Air	58

Fluid

Main Gearcase	51
Transmission	51

Fluid Change

Main Gearcase	51
Transmission	51

Fluid Check

Main Gearcase	51
Transmission	51

Fluid Levels During Storage	76
Fluid, Brake	62
Fogging the Engine	77
Fouled Plugs	54
Freeplay Adjustment, Throttle	60
Freeplay, Steering Wheel	63
Fuel Cap	25
Fuel Safety	17
Fuel Stabilizer	76
Fuel Tank Filler Cap	25

INDEX

- G**
- Gap, Spark Plug 54
 - Gasoline Handling 17
 - Gearcase Oil**
 - Main 51
 - Gearcases**
 - Main Gearcase 51
 - Transmission 51
 - Gloves 9
- H**
- Helmet 9
- I**
- Ignition Switch 22
 - Inspection, Brakes 61
 - Inspection, Pre-Ride 28
 - Inspection, Steering Wheel 63
 - Inspection, Throttle Freeplay 59
 - Installation, Battery 70
- K**
- Key, Periodic Maintenance Chart . . . 42
- L**
- Lamp Replacement**
 - Tail Light 67
 - Lamp Replacement, Daytime Running Lights 67
 - Lights 67
 - Lubrication for Storage 77
 - Lubrication Recommendations 46
- M**
- Maintenance Log 96
 - Maintenance, Periodic 41-45
- N**
- New Operator Procedures 32-33
 - Noise Emission Control System 40
- O**
- Obstacles 39
 - Oil**
 - Engine 47-48
 - Main Gearcase 51
 - Transmission 51
 - Oil Change**
 - Engine Oil 48-50
 - Main Gearcase 51
 - Transmission 51
 - Oil Check**
 - Engine Oil 47
 - Main Gearcase 51
 - Transmission 51
- P**
- Parking Brake Adjustment 53
 - Parking Brake Cable Freeplay Adjustment 53
 - Parking on an Incline 38
 - Parking the Vehicle 31
 - Periodic Maintenance Chart 41-45
 - Plug Condition 54
 - Plug Gap 54
 - Plug Torque 54
 - Plug, Spark 54
 - Plugs, Fouled 54
 - Polishing the Vehicle 74
 - Pre-Ride Inspection 28
- R**
- Refueling Safety 17
 - Registration, Warranty 87
 - Removal, Battery 70
 - Removing the Vehicle from Storage . . 78
 - Reverse 38
 - Riding Gear 8-9

INDEX

S

- Safe Operation Practices 29
 - Safety Labels 18-19
 - Safety Symbols 4
 - Safety Training, ROHVA 29, 32
 - Safety Warnings. 10-17**
 - Age Restrictions 10
 - Carrying a Passenger 12
 - Crossing Hillside 13
 - Driving Downhill Improperly 14
 - Excessive Speeds 13
 - Exposure to Exhaust 17
 - Failure to Inspect 11
 - Frozen Bodies of Water 16
 - Hot Exhaust Systems 17
 - Improper Hill Climbing 14
 - Improper Tires and Maintenance. 16
 - Instruction 10
 - Jumps and Stunts 13
 - Multiple Passengers 12
 - Obstacles 16
 - Operating a Damaged Vehicle. 17
 - Operating on Sand 15
 - Operating Through Water 16
 - Overloading 15
 - Pavement 12
 - Physical Control 13
 - Protective Apparel 12
 - Public Roads 12
 - Reverse 15
 - Rider Height 11
 - Seat Belts 11
 - Slippery Terrain 15
 - Stalling on a Hill 14
 - Turning Improperly 13
 - Unauthorized Use of the Vehicle. 17
 - Unfamiliar Terrain 15
 - Using Alcohol or Drugs 11
 - Seat Belts 21
 - Severe Use Definition 41
 - Shock Spring Adjustment 63
 - Signal Words 4
 - Spark Plug 54
 - Spark Plug Condition 54
 - Spark Plug Gap 54
 - Spark Plug Removal 55
 - Spark Plug Torque 54
 - Spark Plugs, Fouled 54
 - Speed Control System 25
 - Stabilizing the Fuel 76
 - Steering Wheel Adjustment 21
 - Steering Wheel Inspection 63
 - Stopping the Engine 31
 - Storage 73-78
 - Storage and Inspection 77
 - Storage and Lubrication 77
 - Storage Area 77
 - Storage, Battery 71
 - Storage, Covers 77
 - Storage, Fluid Levels 76
 - Storage, Oil Change 76
 - Storage, Removal 78
 - Switches**
 - Ignition 22
- ## T
- Tail Light 67
 - Throttle Freeplay Adjustment 60
 - Throttle Freeplay Inspection 59
 - Throttle Freeplay, Freeplay, Throttle 59
 - Throttle Pedal 25
 - Throttle System 59
 - Tire Tread Depth 65
 - Tires 65-66**
 - Front Wheel Hub Tightening 65
 - Wheel Nut Torque 66
 - Toe Alignment 64
 - Torque, Spark Plug 54
 - Transmission Oil 51
 - Transporting the Vehicle 78
 - Tread Depth, Tire 65
- ## V
- Vehicle Identification Numbers 6
 - Vehicle Immersion 68
 - Vehicle Transport 78
- ## W
- Warning Symbols 4
 - Washing the Vehicle 73-74
 - Water, Immersion of Vehicle 68
 - Wear, Drive Belt 83
 - Wheel Hub Tightening 65
 - Wheel Nut Torque Specifications 66
 - Wheel Replacement 65-66
 - Wheels, Front 65
 - Wheels, Rear 66